



Cerriotti
MADE IN ITALY

Arredo

QUALITA' MADE IN MILANO

Saloni Salons		pag 4
Saloni bla bla bla Bla bla bla salons		pag 33
Posti di lavoro Workstations		pag 37
Poltrone donna Chairs		pag 75
Lavaggi Washes		pag 111
Poltrone uomo Men's Chairs		pag 145
Divanetti Sofas		pag 167
Casse Receptions		pag 175
Finiture legno Wood finishes		pag 185
Lavorazioni Finishes		pag 186
Skai Skai		pag 190

ARREDO

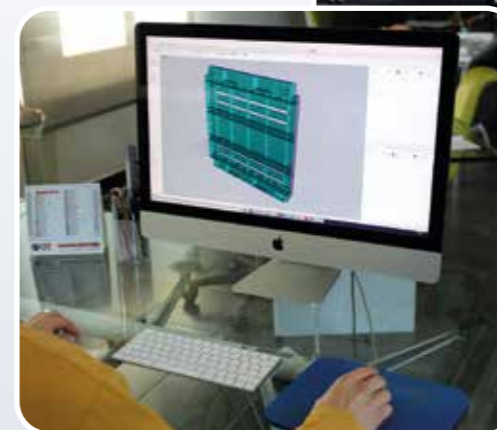

Il progetto: grazie al know-how acquisito in oltre 40 anni di esperienza, alla costante ricerca di soluzioni tecniche innovative ed ai più avanzati strumenti tecnologici trasformiamo un'idea in un prodotto, ingegnerizzato ed industrializzato per offrire standard qualitativi e prestazionali di altissimo livello.

The project: thanks to the know-how acquired in over 40 years of experience, to the constant research for innovative technical solutions and to the most advanced technological tools, we transform an idea into a product, engineered and industrialized to offer the highest quality and performance standards.



La bozza: matita e foglio sono gli strumenti dai quali nascono tutti i prodotti Ceriotti, nei quali coniughiamo le più attuali tendenze stilistiche con le pratiche di utilizzo nel tuo salone.

The draft: pencil and sheet are the tools from which all Ceriotti's products are born, products where we combine the latest stylistic trends with the practical needs of use in your salon.



Il prototipo: creiamo, testiamo, modifichiamo, collaudiamo; prima di entrare a far parte del normale processo produttivo, realizziamo dei prototipi funzionanti che ci permettano di valutare il prodotto nell'uso che ne farai quotidianamente.

The prototype: we create, try, modify, test; before becoming part of the normal production process, we make working prototypes that allow us to evaluate the product in the use you make of it every day.



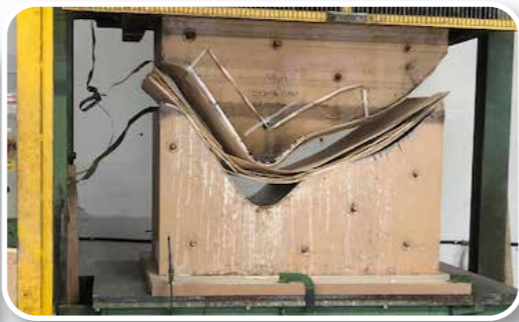

Lo stampo: disegniamo e realizziamo internamente gli stampi dei nostri prodotti, per poter dare il carattere distintivo che li rendono unici e per poter intervenire in tutte le fasi della loro "vita" migliorandone le caratteristiche o adattandoli alle tue esigenze.

The mold: we design and manufacture the molds of our products in-house, in order to give them the distinctive character that make them unique and to be able to intervene in all phases of their "life" by improving their characteristics or adapting them to your needs.



L'assemblaggio: è la componente "artigianale" a far sì che ogni prodotto Ceriotti sia "unico", perché assemblato a mano con cura, passione e professionalità; l'esperienza e l'attenta pianificazione dei processi di produzione ed assemblaggio ci permettono così di rispondere con rapidità e flessibilità alle tue richieste.

Assembly: it is the "artisanal" touch that ensures that each Ceriotti's product is "unique", because it is assembled by hand with care, passion and professionalism; the experience and the careful planning of production and assembly processes allow us to respond quickly and flexibly to your requests.

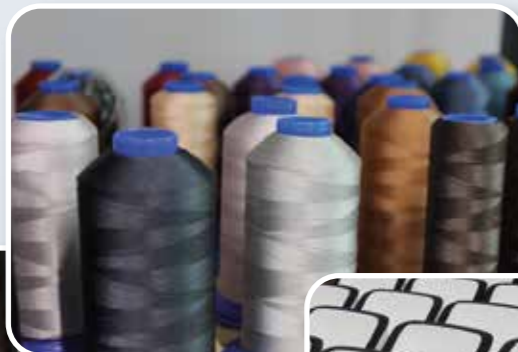

Il materiale: scegliamo accuratamente il processo produttivo ed il materiale da impiegare per la realizzazione di ciascun prodotto; utilizziamo curvati di legno di altissima qualità e resistenza, schiume poliuretatiche ad elevata densità e bassa deformabilità, materie plastiche di prima scelta, alluminio ad elevata purezza lavorato con stampi in pressofusione o in conchiglia.

The material: we carefully choose the production process and the material to be used for creating each product; we use high quality and high resistance wood frames, high density and low deformability polyurethane foams, first choice plastics, high purity aluminum worked with die-cast or shell molds, always seeking the right balance between aesthetics, practicality, durability and "value for money".



La confezione: scegliamo i colori ed i materiali della nostra cartella skai per essere sempre allineati con le tendenze del mondo della moda e con gli standard qualitativi più elevati, e li lavoriamo a mano e amacchina per offrire finiture sartoriali ricercate che rendano ogni prodotto il "tuo" prodotto.

The tailoring: we choose the colors and materials of our skai chart to be always aligned with the trends of the fashion industry and with the highest quality standards, and we work them by hand and machine to offer sophisticated tailored finishes that make each product "your own" product.



L'imballaggio: selezioniamo la forma, la dimensione ed il materiale dei nostri imballi per proteggere la bellezza e l'integrità dei prodotti in tutto il percorso che li porterà fino al tuo salone.

The packaging: we select the shape, size and material of our packaging to protect the beauty and integrity of the products throughout the journey that will take them to your salon.



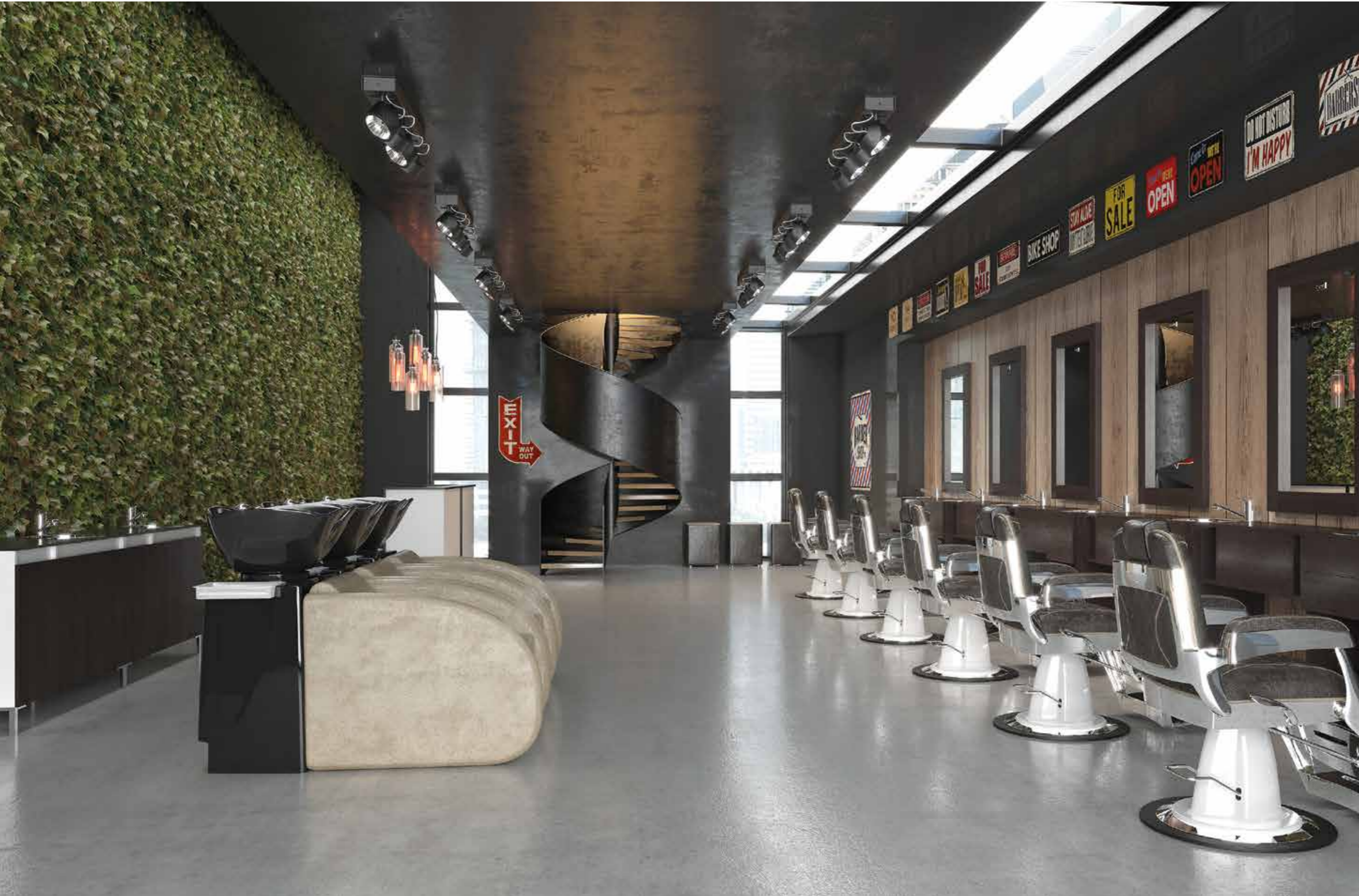

Salone Tivoli



Salone Monterosso "uomo"



Salone Monterosso "donna"





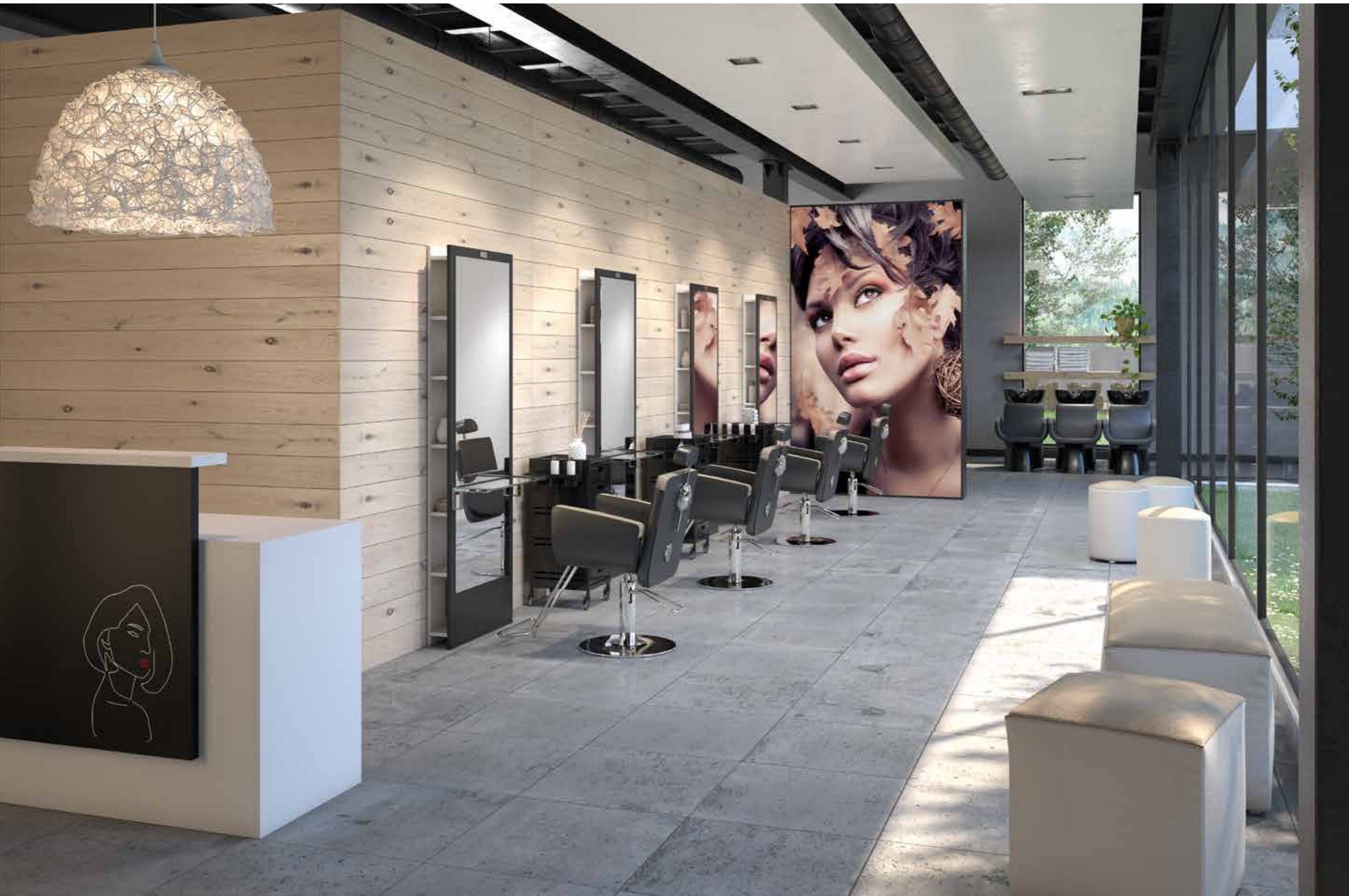



Salone Amalfi



Salone Volterra



Salone Sorrento



Salone Modena



Salone Arona







Salone Burano



Salone Napoli



Salone Michelangelo



Salone Viareggio



Salone Tintoretto



Bla..Bla..Bla..
www.ceriotti.it

Salone Leonardo 2020



Bla..Bla..Bla..
www.ceriotti.it

Ceriotti
MADE IN ITALY

Salone Donatello 2020



Bla..Bla..Bla..
www.ceriotti.it

Salone Italia 2020



Bla..Bla..Bla..
www.ceriotti.it

Salone Raffaello 2020

SOLITAIRE	pag 38
TONDO	pag 40
HULAHOOP	pag 41
STATE S	pag 42
FRASSINO	pag 44
FLUT	pag 46
NAMI	pag 48
JILL	pag 50
KOBY MIRROR	pag 51
BLACK STAR	pag 52
LIGHT	pag 54
LUME	pag 55
MEMORY S	pag 56
FAIR	pag 58
VERSO	pag 60
EKO S	pag 62
BACKSTAGE	pag 64
STYLO 2P	pag 65
ROY S	pag 66
IDEO PLUS	pag 67
EXPO	pag 68
ESSENTIAL	pag 69
AREZZO • ROMA	pag 70
TORINO • PARMA	pag 71
MOBILETTI	pag 72
ACCESSORI	pag 73

**.POSTI DI LAVORO.
 .WORKSTATIONS.**



FINITURE S
 Finish S - Finition S
 Verschalung S - Acabado S



PORTAPHON
 Holder for hairdryer - Support pour sechoir
 Halterung für Haartrockner - Soporte para secador



PREDISPOSIZIONE ELETTRICA
 Electric sockets - Prises électriques
 Steckdosen - Enchufes eléctricos



FINITURA PIANETTO S
 Worktop finish - Finition du top
 Verschalung des Bretts - Acabado del estante



COLORE ORO
 Gold colour - Couleur or
 Goldene Farbe - Color dorado



SALONE
 Salons - Salons
 Salons - Salons



PIANETTO OPTIONAL
 Optional worktop - Top en option
 Auf Wunsch Brett - Estante opcional



COLORE NERO
 Black colour - Couleur noire
 Schwarze Farbe - Color negro



SPEDIZIONE VELOCE
 Express shipping - Expédition express
 Express Versand - Envío rapido



ILLUMINAZIONE
 Lighting - Éclairage
 Beleuchtung - Iluminación



SOLITAIRE LIGHT
Cod. 9830NL

SOLITAIRE
Cod. 9830N



SOLITAIRE
Cod. 9830

Salone
Sanremo
pag. 26

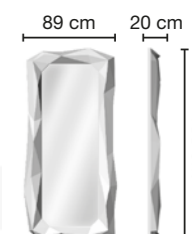



Cod. 9820

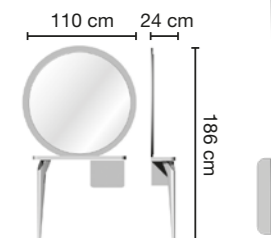

Salone Sorrento pag. 20
Salone Arona pag. 24



HULAHOOP LIGHT
Cod. 9831L

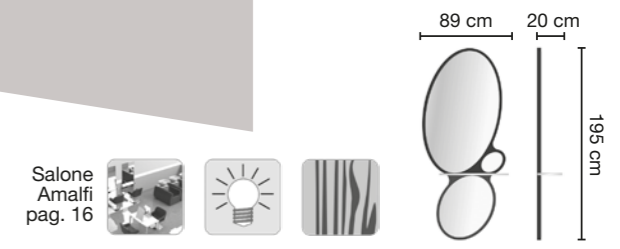

Salone Amalfi pag. 16



Cod. 9879



Cod. 9879S

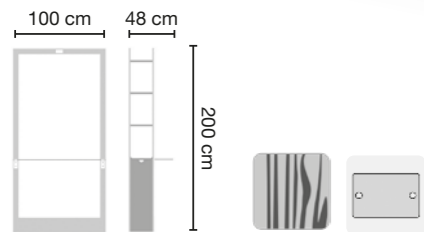

Cod. 9896



Salone
Monterosso
pag. 8

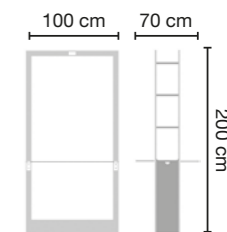

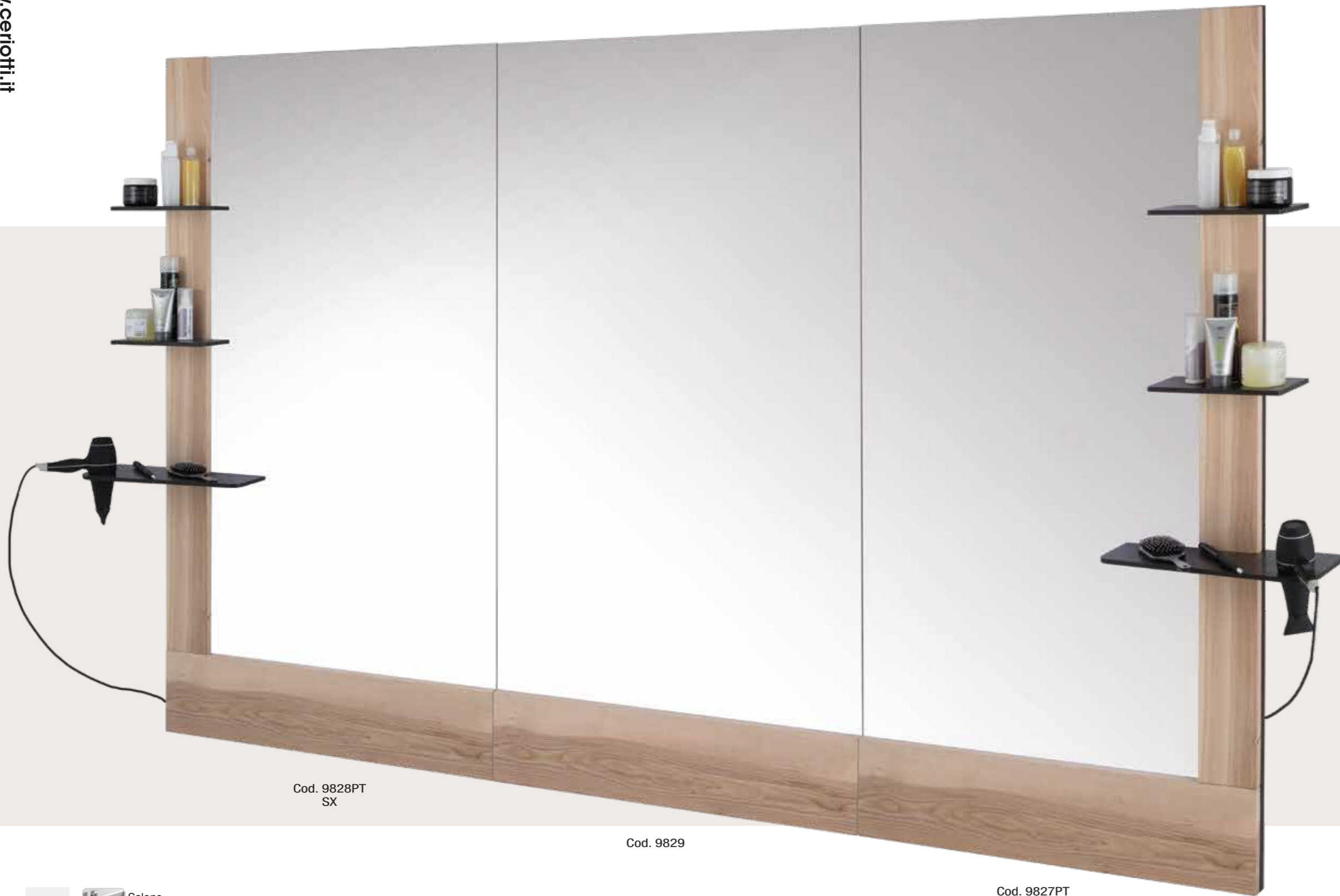

Cod. 9827
DX



Cod. 9829



Cod. 9828
SX



Salone
Ivrea
pag. 10

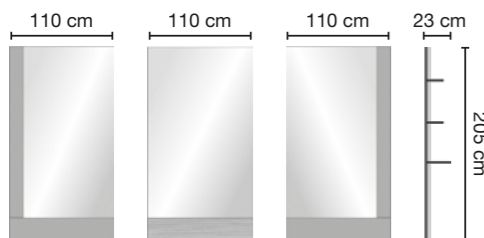

COMPOSIZIONI

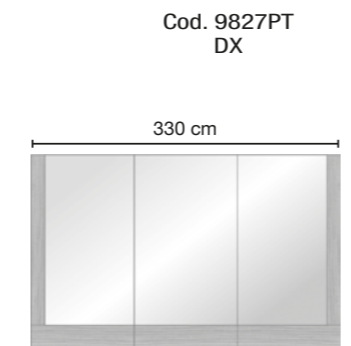
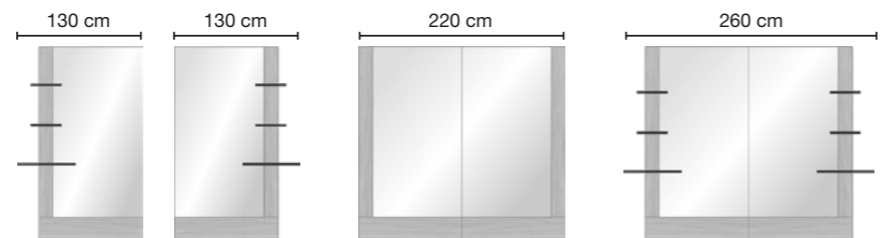



FLUT
Cod. 9821



FLUT LIGHT
Cod. 9821L

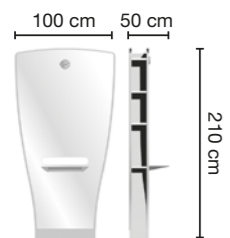

FLUT db LIGHT
Cod. 9822EL

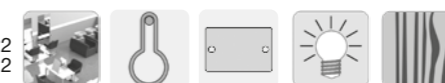
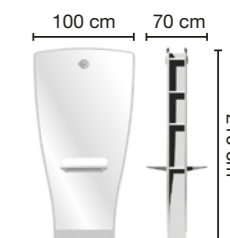

Salone Modena pag. 22
Salone Brescia pag. 12



NAMI LIGHT
Cod. 9881NL



Cod. 9881



Cod. 9881G

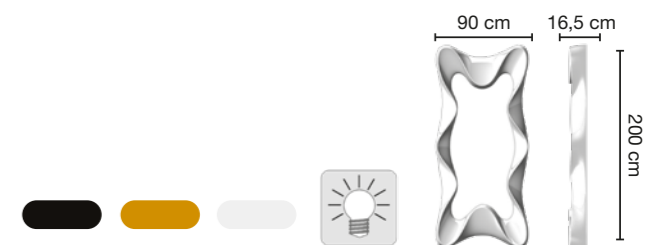
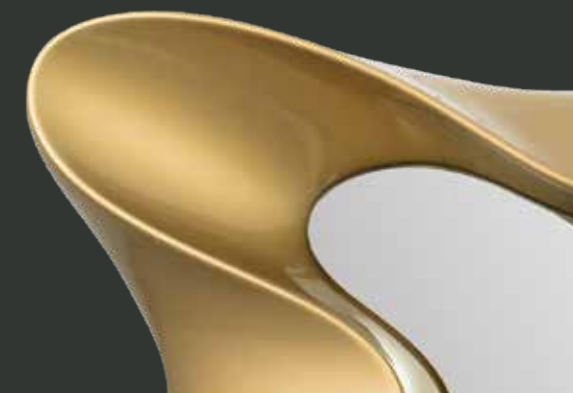



JILL
Cod. 9853

JILL LIGHT
Cod. 9853L

Cod. 9701

Cod. 9701

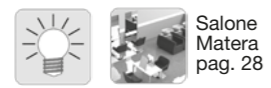
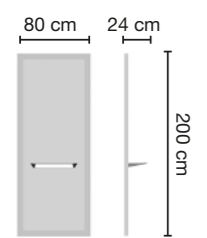

Cod. 9804N

Cod. 9705



KOBY
Cod. 9803

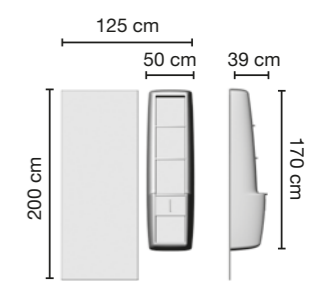



Cod. 9826L
LIGHT



Cod. 9826

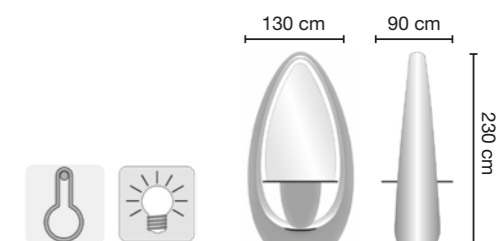



Cod. 9802



Cod. 98155PT



Cod. 98155

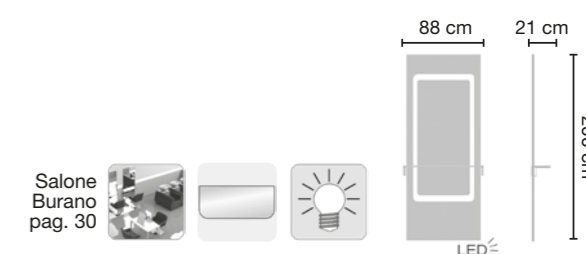
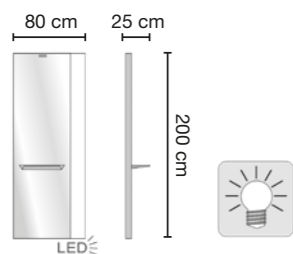



Cod. 9817SE



Cod. 9817E

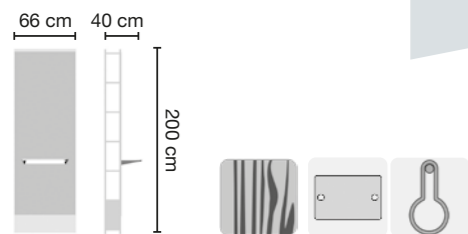

Cod. 9805SE



Cod. 9805E

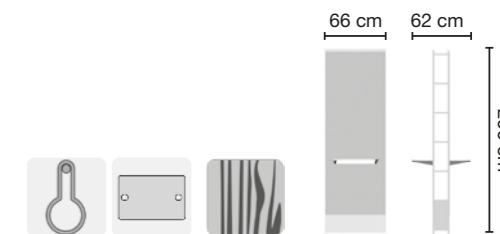



FAIR P
Cod. 9806S



FAIR 2P
Cod. 9807



FAIR 2C
Cod. 9808



FAIR2C
Cod. 9808CM



FAIR 4C
Cod. 9812SCM

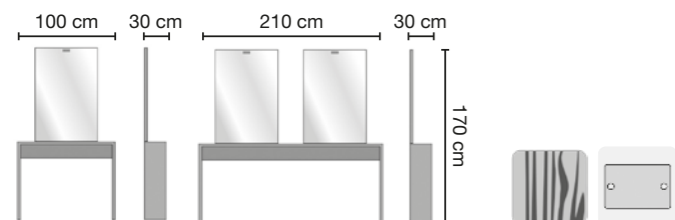

Salone
Volterra
pag. 18

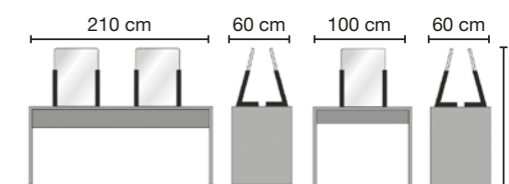
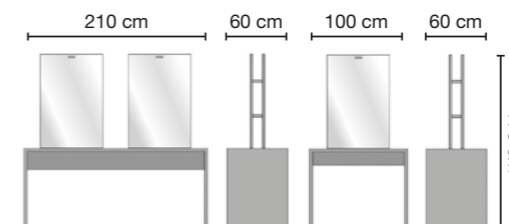



VERSO 2
Cod. 9897P



VERSO 4-R
Cod. 9800S



VERSO 4-O
Cod. 9801P

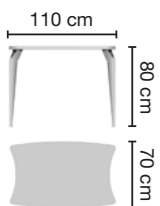

Salone
Matera
pag. 28

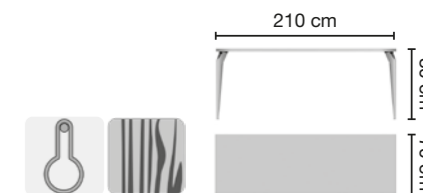
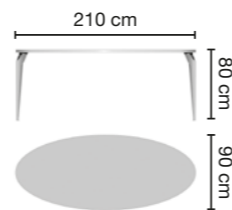



EKO S
Cod. 9813S



EKO S
Cod. 9813



EKO S LIGHT
Cod. 9813SL



Cod. 9813F

Cod. 9813SF

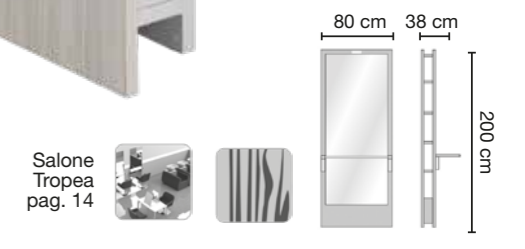
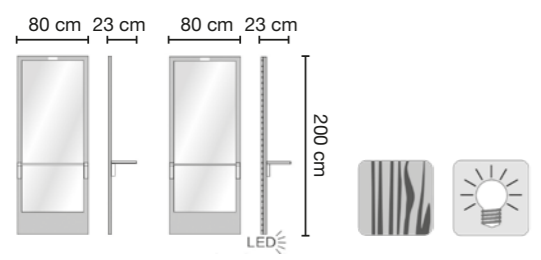



BACKSTAGE
Cod. 9823



BACKSTAGE ALU
Cod. 9824

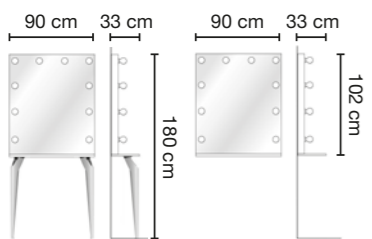

Salone
Sorrento
pag. 20



Cod. 9810



Cod. 9810N





Cod. 9815S



Cod. 9815

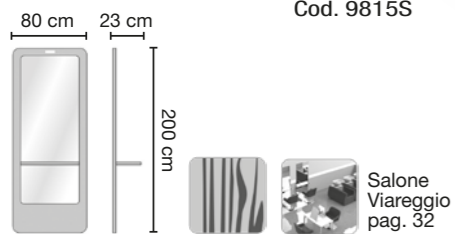

Salone
Viareggio
pag. 32



Cod. 9883SL



Cod. 9883

Cod. 9701

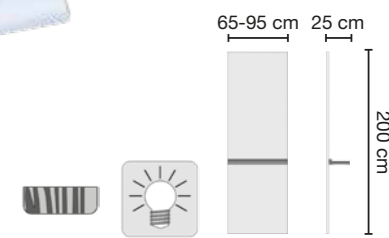



Cod. 9900

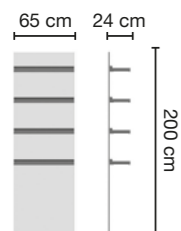

Cod. 9861

Cod. 9701

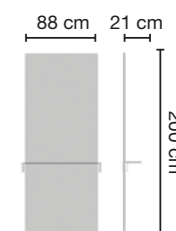



AREZZO
Cod. B9819



ROMA
Cod. B9817



TORINO
Cod. B9818



PARMA
Cod. B9832

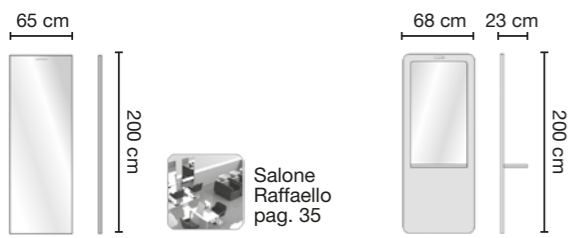

MOBILETTI



TYPE 9915



CLIP 9918



B-TYPE 9916



B-CLIP 9919



S-TYPE 9914



S-CLIP 9917

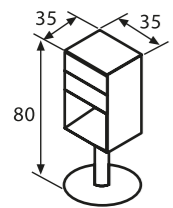
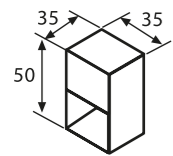
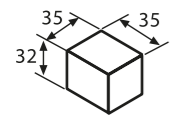

in cm.

TYPE e CLIP

PIANETTI



9903



9901

PORTA PHON

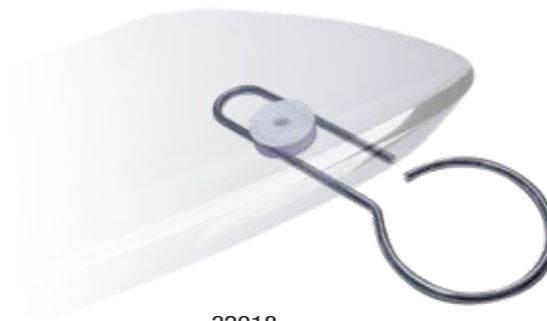

32018

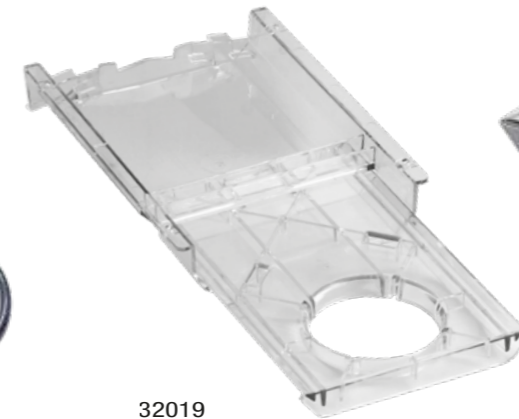

32019



32017

POGGIA PIEDI



9705



9701



9706

LEIDY SUPERIOR	pag 76
CLARISSA	pag 78
FRAC	pag 80
LULU'	pag 81
SABRINA	pag 82
SUPERIOR CLASS	pag 83
GRETA	pag 84
FLEX	pag 86
MARTINA	pag 87
ASTRID	pag 88
MARICA	pag 89
VERUSKA	pag 90
CLOUD	pag 91
OLIVIA	pag 92
GAIA	pag 94
SOFIA	pag 96
EMMA	pag 97
CAROL	pag 98
ZOE	pag 99
LARA	pag 100
NAPOLI	pag 102
FIRENZE	pag 103
LUCCA	pag 104
SIENA	pag 105
ENNA	pag 106
JINNI	pag 107
TAO • TOM&JERRY	pag 108
BASI	pag 109

**.POLTRONE DONNA.
.CHAIRS WOMAN.**



SKAI S pag 190



LAVORAZIONE STAMPA (SKAI)
Embossed finish - Finition emboss
Geprägt Handwerksarbeit - Acabado en relieve



LAVORAZIONE TRAPUNTATA (SKAI)
Quilted finish - Finition matelassée
Gesteppte Handwerksarbeit - Acabado acolchado



LAVORAZIONE RICAMO (SKAI)
Embroidered finish - Finition brodée
Besticktes Handwerksarbeit - Acabado bordado



LAVORAZIONE PAILLETES (SKAI)
Decoration with sequins - Décoration avec des paillettes
Dekoration mit Pailletten - Decoración con lentejuelas



BASE POLTRONA pag 109
Chair base - Base de Fauteuil
Base sillon - Friseurstuhl basis



LAVORAZIONE STAMPA PERSONALIZZATA (PREVENTIVO)
Customized embossed finish (quotation)
Finition emboss (devis)
Personalisiert geprägt Handwerksarbeit (Voranschlag)
Acabado en relieve personalizado (cotización)



LAVORAZIONE RICAMO PERSONALIZZATO (PREVENTIVO)
Customized embroidered finish (quotation)
Finition brodée personnalisée (devis)
Personaliziert besticktes Handwerksarbeit (Voranschlag)
Acabado bordado personalizado (cotización)



SALONE
Salons - Salons
Salons - Salons



SPEDIZIONE VELOCE
Express shipping - Expédition express
Express Versand - Envío rápido



Cod. 405306
T1



Cod. 405306
T6

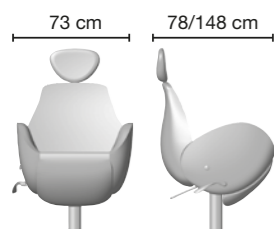

Salone Sorrento pag. 20



Cod. T: T1 - T2 - T4 - T6

TRAPUNTATO
QUILTED

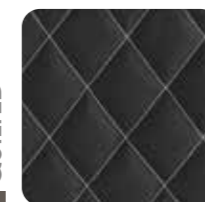

Cod T1



Cod T2

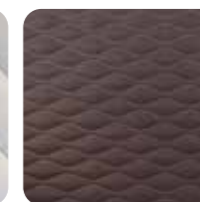

Cod T4

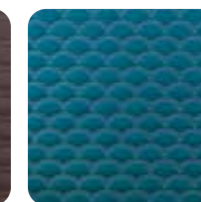

Cod T6



TRAPUNTATO
QUILTED



Cod T1

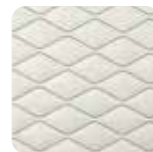

Cod T3

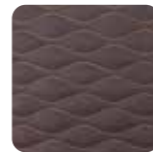

Cod T4

RICAMATO
EMBROIDERED



Cod RS1



Cod. RS2



Cod RS3 ITA
Cod RS3 ENG
Cod RS3 FRA



Cod. RF22

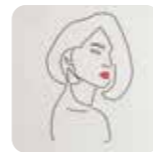

Cod. RV11

PAILLETTES
SEQUINS

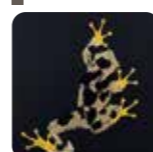

Cod. PA1



Cod. 411905 Rif. 5



Cod. T: T1 - T3 - T4
Cod. R: RS1 - RS2 - RS3 - RF22 - RV11
Cod. P: PA1

pag. 109

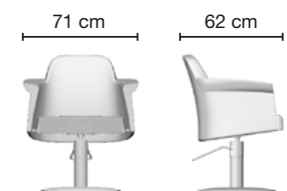



Cod. 409106 Rif. 6
T3 - RS3



Cod. 410105 Rif. 5

TRAPUNTATO
QUILTED



Cod T1



Cod T3

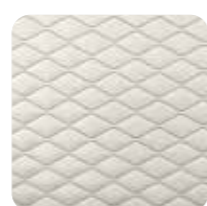

Cod T4

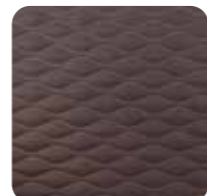

Cod T5



Cod T6

RICAMATO
EMBROIDERED



Cod RS2



Cod RS3 ITA
Cod RS3 ENG
Cod RS3 FRA



Cod RF22



Cod RF23



Cod RV11



Cod RA31

PAILLETES
SEQUINS



Cod PA1



Cod PA2



Cod PA3



Cod PF11



Cod PF12

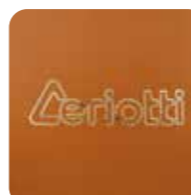

Cod PS21

IL TUO LOGO
YOUR LOGO



Cod RS1



Cod ST

Il tuo logo, ricamato o stampato sui tuoi arredi, ora è realtà. Scegli lo skai ed il colore del filo, inviaci il tuo logo e lo vedrai riprodotto sui tuoi arredi.

Your logo, embroidered or embossed on your furniture, is now reality. Choose the skai and the color of the thread, send us your logo and you will see it reproduced on your furniture.

Cod. T: T1 - T3 - T4 - T5 - T6
Cod. R: RA31 - RF22 - RS1 - RS3 - RV11
Cod. P: PA1 - PF11 - PF12 - PS21

Cod. R: RS1 - RS2 - RS3 - RF22 - RF23
Cod. P: PA2 - PA3 - PF12

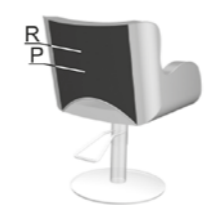
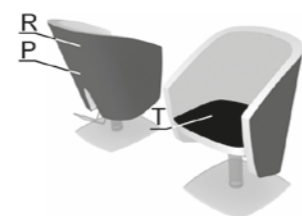
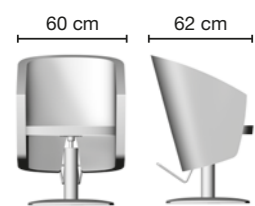



Cod. 411806 Rif. 6 T1

TRAPUNTATO
QUILTED



Cod T1



Cod T2



Cod T3



Cod T4



Cod T5



Cod T6



Cod T7

RICAMATO
EMBROIDERED



Cod RS2



Cod RS3 ITA
Cod RS3 ENG
Cod RS3 FRA



Cod RF21



Cod RF22



Cod RF23



Cod RV11



Cod RA31

PAILLETES
SEQUINS



Cod PA1



Cod PA2



Cod PA3



Cod PF11



Cod PF12



Cod PF13



Cod PS21

IL TUO LOGO
YOUR LOGO



Cod RS1



Cod ST

Il tuo logo, ricamato o stampato sui tuoi arredi, ora è realtà. Scegli lo skai ed il colore del filo, inviaci il tuo logo e lo vedrai riprodotto sui tuoi arredi.

Your logo, embroidered or embossed on your furniture, is now reality. Choose the skai and the color of the thread, send us your logo and you will see it reproduced on your furniture.



Cod. 411805 Rif. 5

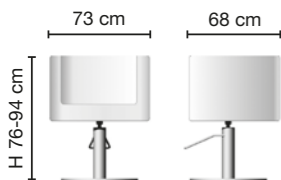

pag. 109



Salone
Modena
pag. 22



Cod. T: T1 - T2 - T7
Cod. R: RS1 - RS2 - RS3 - RF21 - RF22
Cod. P: PF11 - PF12 - PF13 - PS21



Cod. T: T1 - T5 - T7
Cod. R: RS1 - RF21 - RF23
Cod. P: PA1 - PA2 - PA3 - PF11

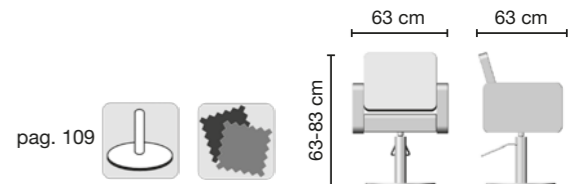

pag. 109



TRAPUNTATO
QUILTED

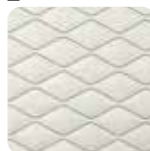

Cod. T3

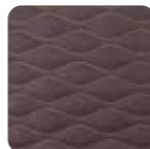

Cod. T4

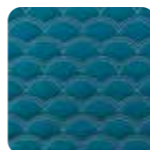

Cod. T6

RICAMATO
EMBROIDERED



Cod. RS2



Cod. RS3 ITA
Cod. RS3 ENG
Cod. RS3 FRA



Cod. RF22

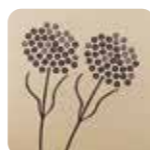

Cod. RF23

PAILLETES
SEQUINS



Cod. PA1



Cod. PA3



Cod. PF13

IL TUO LOGO
YOUR LOGO



Cod. RS1

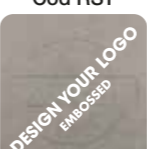

Cod. ST



Cod. 412006 Rif. 6

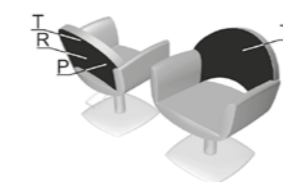

Cod. T: T3 - T4 - T6
Cod. R: RS1 - RS2 - RRS3 - RF23
Cod. P: PA1 - PA3 - PF13

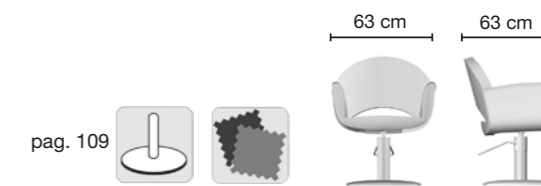



**TRAPUNTATO
QUILTED**



Cod T1



Cod T2



**RICAMATO
EMBROIDERED**



Cod RS3 ITA
Cod RS3 ENG
Cod RS3 FRA



Cod RF21



Cod RF22



Cod RV11



Cod RA31

**PAILLETES
SEQUINS**



Cod PA1



Cod PA3



Cod PF11



Cod PF12



Cod PS21

**IL TUO LOGO
YOUR LOGO**



Cod RS1



Cod ST

Il tuo logo, ricamato o stampato sui tuoi arredi, ora è realtà. Scegli lo skai ed il colore del filo, inviaci il tuo logo e lo vedrai riprodotto sui tuoi arredi.

Your logo, embroidered or embossed on your furniture, is now reality. Choose the skai and the color of the thread, send us your logo and you will see it reproduced on your furniture.



Cod. 409306 Rif. 6
RF22



Cod. 409405 Rif.5
T1

Cod. T: T1 - T2
Cod. R: RA31 - RF22 - RS1 - RS3 - RV11
Cod. P: PA3 - PF11 - PF12 - PS21



Cod. T: T1 - T2
Cod. R: RA31 - RF21 - RF22 - RS1 - RS3 - RV11
Cod. P: PA1 - PF11 - PF12 - PS21

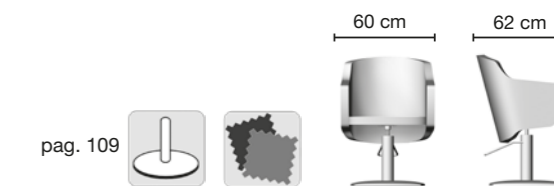
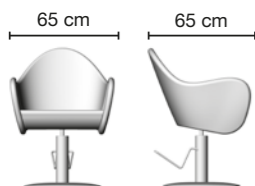
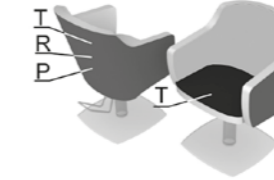



TRAPUNTATO
QUILTED



Cod T1

RICAMATO
EMBROIDERED



Cod RS2

PAILLETES
SEQUINS



Cod PA1

IL TUO LOGO
YOUR LOGO



Cod RS1



Cod PA2



Cod ST

Il tuo logo, ricamato o stampato sui tuoi arredi, ora è realtà. Scegli lo skai ed il colore del filo, inviaci il tuo logo e lo vedrai riprodotto sui tuoi arredi.

Your logo, embroidered or embossed on your furniture, is now reality. Choose the skai and the color of the thread, send us your logo and you will see it reproduced on your furniture.



Cod T4



Cod RF23



Cod T6



Cod PF13



Cod PS21



Cod. 410606 Rif. 6
T6 - PA1



Cod. 410505 Rif. 5
RS2

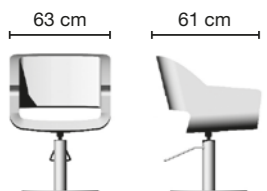

pag. 109



Salone Ivrea pag. 10



Cod. R: RS1 - RS2 - RF23
Cod. P: PA2 - PS21

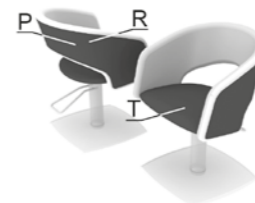

Cod. T: T1 - T4 - T6
Cod. R: RS1 - RS2 - RF23
Cod. P: PA2 - PF13



pag. 109

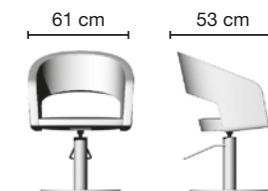



Cod. 408505 Rif. 5



Cod. 408106 Rif. 6

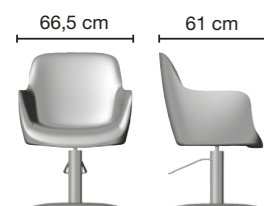

pag. 109



Salone
Monterosso
pag. 8

Salone
Burano
pag. 30

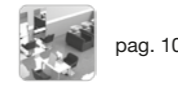

pag. 109

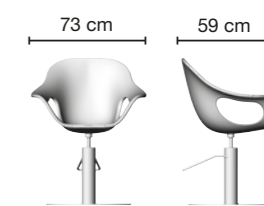



Cod. 410005 Rif. 5

**TRAPUNTATO
QUILTED**



Cod T1



Cod T2

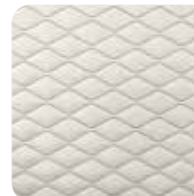

Cod T3

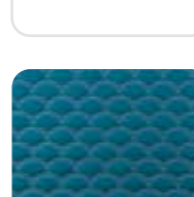
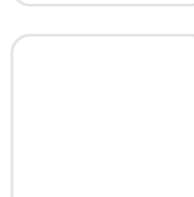
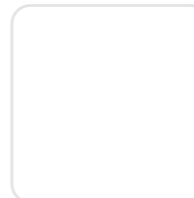

Cod T6

**RICAMATO
EMBROIDERED**



Cod RS2



Cod RS3 ITA
Cod RS3 ENG
Cod RS3 FRA



Cod RF22



Cod RF23



Cod RV11

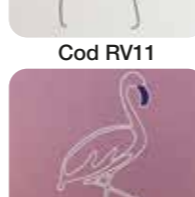

Cod RA31

**PAILLETES
SEQUINS**



Cod PA1



Cod PF11



Cod PS21

**IL TUO LOGO
YOUR LOGO**



Cod RS1

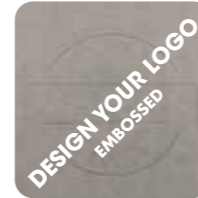

Cod ST

Il tuo logo, ricamato o stampato sui tuoi arredi, ora è realtà. Scegli lo skai ed il colore del filo, inviaci il tuo logo e lo vedrai riprodotto sui tuoi arredi.

Your logo, embroidered or embossed on your furniture, is now reality. Choose the skai and the color of the thread, send us your logo and you will see it reproduced on your furniture.



OLIVIA MAKE UP
Cod. 410006APAT Rif. 6



OLIVIA RECLINER
Cod. 411605AP Rif. 5
T2

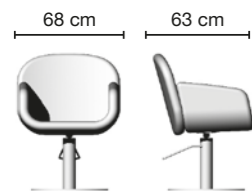

Cod. T: T1 - T2 - T3
Cod. R: RF23 - RS1 - RS3 - RV11 - RF22
Cod. P: PA1 - PF11 - PS21

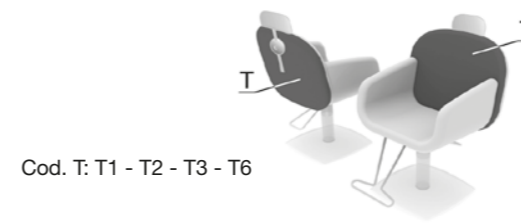

Cod. T: T1 - T2 - T3 - T6



Salone
Amalfi
pag. 16

pag. 109



**TRAPUNTATO
QUILTED**



Cod T1



Cod T2



Cod T3



Cod T5

**RICAMATO
EMBROIDERED**



Cod RS2



Cod RS3 ITA
Cod RS3 ENG
Cod RS3 FRA



Cod RF22

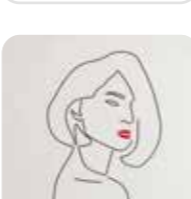

Cod RV11



Cod RA31

**PAILLETES
SEQUINS**



Cod PA1



Cod PA3



Cod PF11



Cod PF12



Cod PS21

**IL TUO LOGO
YOUR LOGO**



Cod RS1



Cod ST

Il tuo logo, ricamato o stampato sui tuoi arredi, ora è realtà. Scegli lo skai ed il colore del filo, inviaci il tuo logo e lo vedrai riprodotto sui tuoi arredi.

Your logo, embroidered or embossed on your furniture, is now reality. Choose the skai and the color of the thread, send us your logo and you will see it reproduced on your furniture.



GAIA MAKE UP
Cod. 410205APAT Rif. 5



Cod. 410206 Rif. 6



GAIA RECLINER
Cod. 411705AP Rif. 5

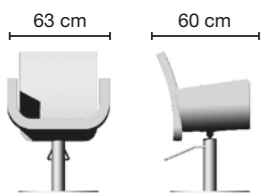

Cod. T: T1 - T2 - T3 - T5
Cod. R: RA31 - RF22 - RS1 - RS2 - RV11
Cod. P: PA1 - PA3 - PF11 - PF12 - PS21

Cod. T: T1 - T2 - T3 - T5

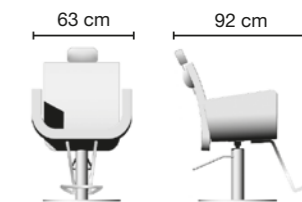



TRAPUNTATO
QUILTED



Cod T1

RICAMATO
EMBROIDERED



Cod RS2

PAILLETES
SEQUINS



Cod PA1

IL TUO LOGO
YOUR LOGO



Cod RS1



Cod RS3 ITA
Cod RS3 ENG
Cod RS3 FRA



Cod PA2



Cod ST



Cod T3



Cod RF23



Cod PF13



Cod T5



Cod PS21

Il tuo logo, ricamato o stampato sui tuoi arredi, ora è realtà. Scegli lo skai ed il colore del filo, inviaci il tuo logo e lo vedrai riprodotto sui tuoi arredi.

Your logo, embroidered or embossed on your furniture, is now reality. Choose the skai and the color of the thread, send us your logo and you will see it reproduced on your furniture.



Cod. 410709 Rif. 9
T1 - RS3



Cod. 410305 Rif. 5
RS1

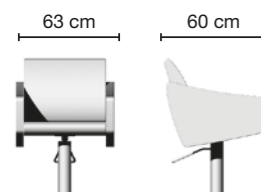

Cod. T: T1 - T3 - T5
Cod. R: RS1 - RS2 - RS3 - RF23
Cod. P: PA1 - PA2 - PS21 - PF13



Cod. R: RS1 - RS2
Cod. P: PA2 - PS21

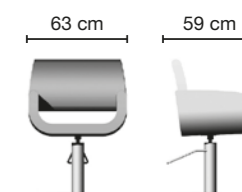



Cod. 410405 Rif. 5



Cod. 410806 Rif. 6

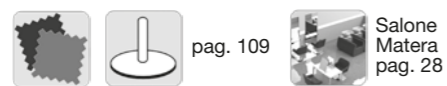
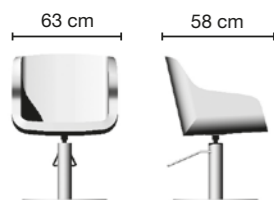

pag. 109



Salone
Matera
pag. 28



pag. 109



Salone
Viareggio
pag. 32

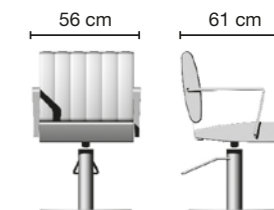



LARA
Cod. 409706 Rif. 6



LARA ICE
Cod. 409706T Rif. 6



LARA ICE CONFORT
Cod. 409606T Rif.6



LARA CONFORT
Cod. 409606 Rif.6

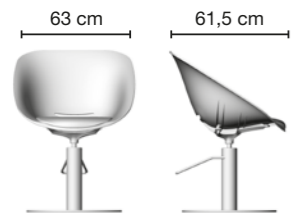

pag. 109

Colori / Colours

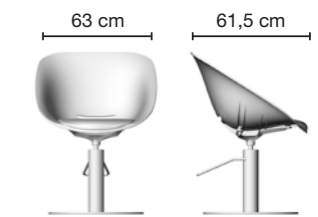

Colori / Colours

pag. 109



Bla..Bla..Bla..
www.ceriotti.it



Cod. B411109 Rif.9

NAPOLI

Bla..Bla..Bla..
www.ceriotti.it



Cod. B410909 Rif. 9

FIRENZE

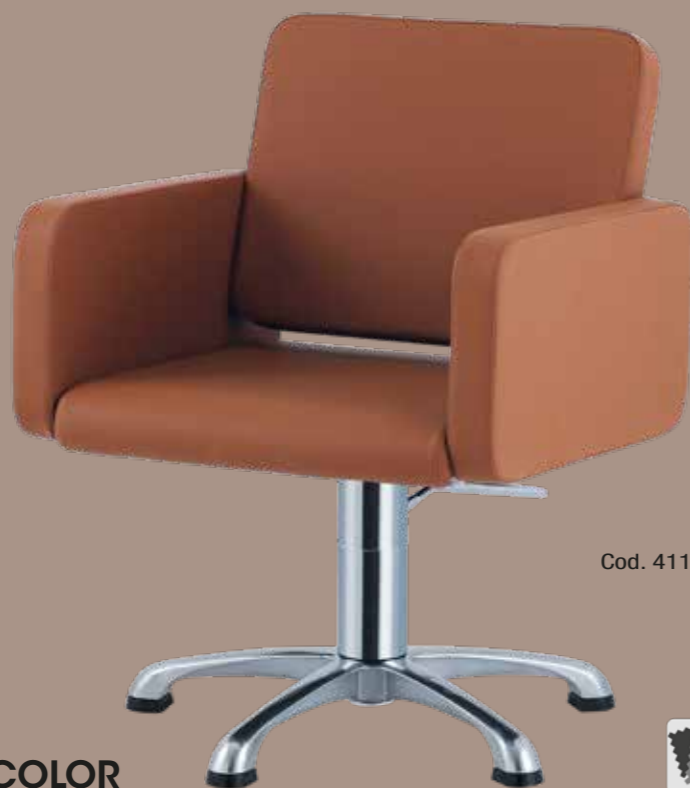

Cod. 411309 Rif. 9

NAPOLI COLOR



pag. 109



pag. 109



Cod. 411409 Rif. 9

FIRENZE COLOR

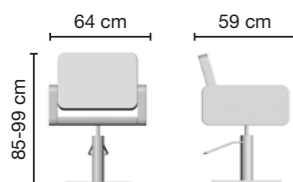

Salone
Leonardo
pag. 34

Salone
Italia
pag. 34

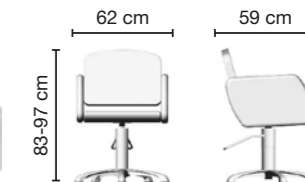

Bla..Bla..Bla..
www.ceriotti.it



Cod. B411209 Rif.9

LUCCA

Bla..Bla..Bla..
www.ceriotti.it



Cod. B411009 Rif. 9

SIENA



Cod. 409809 Rif. 9

LUCCA CONFORT



pag. 109



pag. 109



Cod. 411509 Rif. 9

SIENA COLOR

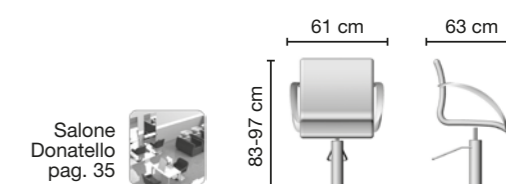
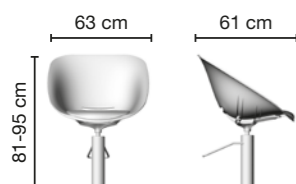

Bla..Bla..Bla..
www.ceriotti.it



Cod. B411609 Rif.9

ENNA



Cod. 411709 Rif. 9

ENNA COLOR



pag. 109

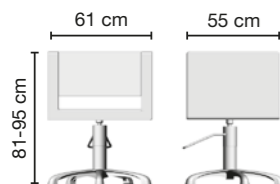

Salone
Tintoretto
pag. 33



Cod. 4913



Cod. 4912N

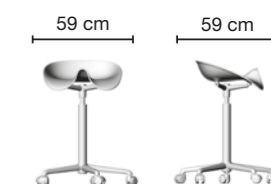



DUETTO SUPERIOR	pag 112
TOURING SUPERIOR	pag 114
TOURING	pag 115
DUETTO	pag 116
ALZAMI	pag 118
ALLUMINIUM CLOUD	pag 119
DOMO SHIATSU	pag 120
DOMO	pag 121
BOTE'	pag 122
IMPERIAL	pag 124
EMOTION	pag 126
HIRO	pag 127
RELAX	pag 128
SKID	pag 130
SOFT	pag 131
OXFORD	pag 132
FIBER GAIA	pag 133
FIBER LARA	pag 134
FIBER EMMA	pag 135
FIBER SOFIA	pag 136
FIBER SUPERIOR CLASS	pag 137
GENOVA	pag 138
VENEZIA	pag 139
MILANO	pag 140
LIVORNO	pag 141
LAVAGGI A COLONNA	pag 142
MOBILI DI SERVIZIO	pag 143

LAVAGGI. WASHES.



LAVELLO NERO
Black ceramic basin - Cuvette en céramique noire
Schwarze Keramik-Waschschüssel
Pica de cerámica negra



DOCCETTA MONOFORO
Anti-drop mixer - Mélangeur anti-goutte
Antitropf-Mischer - Mezclador anti-goteo



SALVACOLLO
Silicone neck support - Support de cou en silicone
Silikon Nackenstütze - Soporte de cuello de silicona



COLONNA LAVAGGIO NERO
Black column - Colonne noire
Schwarze Spalte - Columna negra



VASCHETTA DUETTO - TOURING
Bowl for Duetto - Bol pour Duetto
Schüssel für Duetto - Cuenco para Duetto



VASCHETTA DUETTO - TOURING CON SCARICO
Bowl for Duetto with drain - Bol pour Duetto avec drain
Schüssel für Duetto mit Wasserablauf
Cuenco para Duetto con descarga de agua



MOVIMENTO ALZAMI
Electrical height adjustment (Alzami)
Réglage en hauteur électrique (Alzami)
Elektrische Höhenverstellung (Alzami)
Regulación eléctrica de altura (Alzami)



BRACCIOLO CENTRALE DUETTO - TOURING
Central armrest Duetto - Accoudoir central Duetto
Zentrale Armlehne Duetto - Apoyabrazos central Duetto



ALZGAMBE ELETTRICO
Legrest (electrical) - Repose-jambes (électrique)
Beinstütze (elektrisch) - Reposapiernas (eléctrico)



VIBROMASSAGGIO CON ALZGAMBE ELETTRICO
Vibromassage + legrest (electrical)
Vibromassage + repose-jambes (électrique)
Vibromassage + Beinstütze (elektrisch)
Vibromasaje + reposapiernas (eléctrico)



MASSAGGIO SHIATSU CON ALZGAMBE
Shiatsu massage + legrest (electrical)
Shiatsu + repose-jambes (électrique)
Shiatsu + reposapiernas (eléctrico)
Shiatsu-Massage + Beinstütze (elektrisch)



SKAI S pag 190



LAVORAZIONE STAMPA (SKAI)
Embossed finish - Finition emboss
Geprägt Handwerksarbeit - Acabado en relieve



LAVORAZIONE TRAPUNTATA (SKAI)
Quilted finish - Finition matelassée
Gesteppte Handwerksarbeit - Acabado acolchado



LAVORAZIONE RICAMO (SKAI)
Embroidered finish - Finition brodée
Besticktes Handwerksarbeit - Acabado bordado



LAVORAZIONE PAILLETES (SKAI)
Decoration with sequins - Décoration avec des paillettes
Dekoration mit Pailletten - Decoración con lentejuelas



LAVORAZIONE STAMPA PERSONALIZZATA (PREVENTIVO)
Customized embossed finish (quotation)
Finition emboss (devis)
Personalisiert geprägt Handwerksarbeit (Voranschlag)
Acabado en relieve personalizado (cotización)



LAVORAZIONE RICAMO PERSONALIZZATA (PREVENTIVO)
Customized embroidered finish (quotation)
Finition brodée personnalisée (devis)
Personalisiert besticktes Handwerksarbeit (Voranschlag)
Acabado bordado personalizado (cotización)



COLORE NERO
Black colour - Couleur noire
Schwarze Farbe - Color negro



SALONE
Salons - Salons
Salons - Salons



SPEDIZIONE VELOCE
Express shipping - Expédition express
Express Versand - Envío rapido



Cod. 57172NBC
T4 - RF21

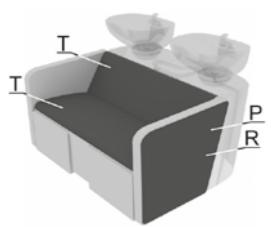

Cod. T: T1 - T4 - T7 • R: - RS1 - RS3 - RF21 • P: PA1 - PF11

TRAPUNTATO QUILTED				RICAMATO EMBROIDERED			PAILLETTES SEQUINS			DESIGN YOUR LOGO EMBROIDERED		DESIGN YOUR LOGO EMBROIDERED	
	Cod T1	Cod T4	Cod T7		Cod RS3 ITA Cod RS3 ENG Cod RS3 FRA	Cod RF21		Cod PA1	Cod PF11		Cod RS1		Cod ST

Salone Modena pag. 22
Salone Arona pag. 24

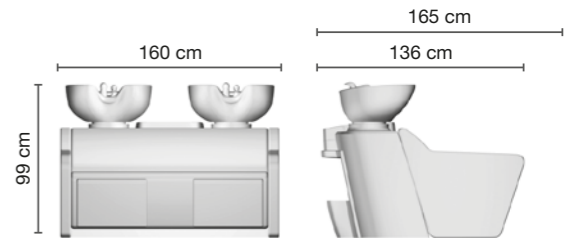



Cod. 57178BCW



Cod. 57177BCW

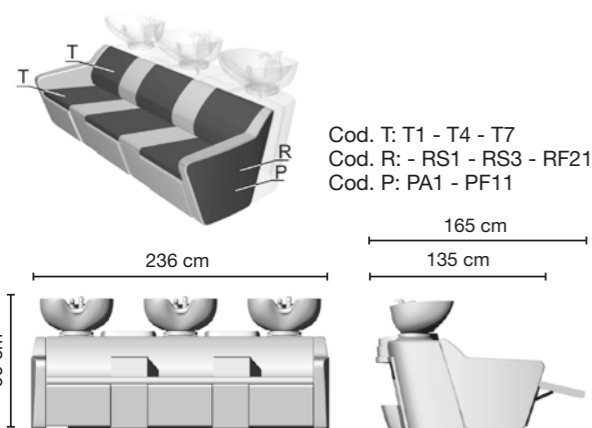

Cod. T: T1 - T4 - T7
Cod. R: - RS1 - RS3 - RF21
Cod. P: PA1 - PF11

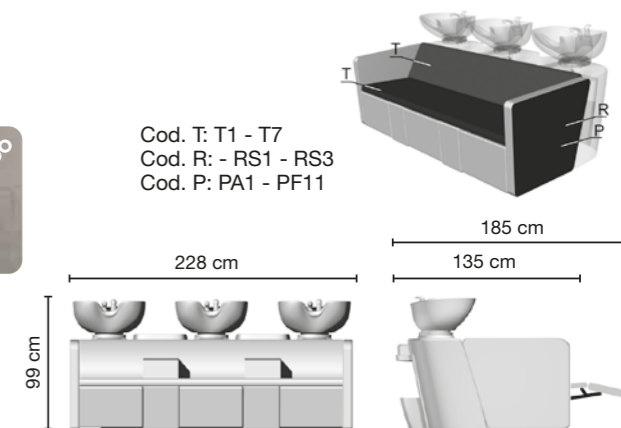
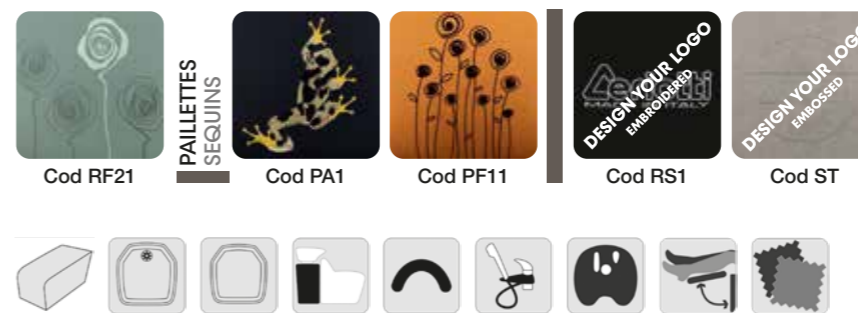
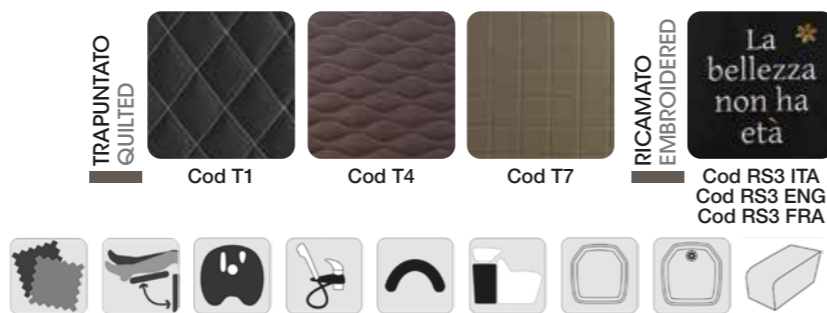

Cod. T: T1 - T7
Cod. R: - RS1 - RS3
Cod. P: PA1 - PF11







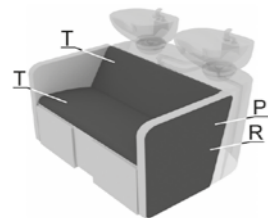

Cod. 57171AW















Cod. 57171ABCW



Cod. T: T1 - T7 • R: - RS1 - RS3 • P: PA1 - PF11

<p>TRAPUNTATO QUILTED</p>  <p>Cod T1</p>	 <p>Cod T7</p>	<p>RICAMATO EMBROIDERED</p>  <p>Cod RS3 ITA Cod RS3 ENG Cod RS3 FRA</p>	<p>PAILLETTES SEQUINS</p>  <p>Cod PA1</p>	 <p>Cod PF11</p>	<p>DESIGN YOUR LOGO EMBROIDERED</p>  <p>Cod RS1</p>	<p>DESIGN YOUR LOGO EMBOSSED</p>  <p>Cod ST</p>
--	---	---	---	---	---	---

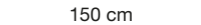
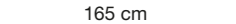
Salone Ivrea pag. 10
Salone Volterra pag. 18

         	<p>150 cm</p> 	<p>165 cm</p> 
<p>99 cm</p> 		



Cod. 57110
T4 - RF21

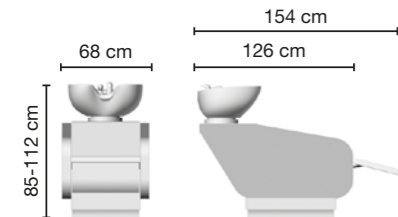

Cod. T: T1 - T4 - T7
Cod. R: - RS1 - RF21 - RV11
Cod. P: PA1 - PF11 - PF13

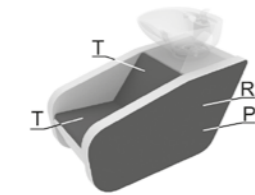

TRAPUNTATO QUILTED			
	Cod T1	Cod T4	Cod T7
RICAMATO EMBROIDERED			
	Cod RF21	Cod RV11	Cod RS1
			Cod ST
PAILLETES SEQUINS			
	Cod PA1	Cod PF11	Cod PF13



Cod. 57092N



Salone
Burano
pag. 30



Cod. 57137NSNH
Massaggio Shiatsu
Alzagambe elettrico
T5 - PA1



Cod. 57137NSN



Cod. T: T1 - T5 - T7
Cod. R: RS1 - RF21 - RF23
Cod. P: PA1 - PF11 - PF13



TRAPUNTATO
QUILTED



RICAMATO
EMBROIDERED

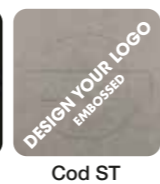

PAILLETES
SEQUINS

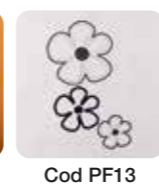

Salone Tivoli pag. 4
Salone Sanremo pag. 26

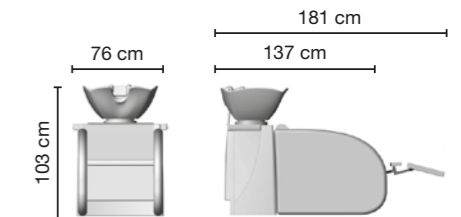



Cod. 57163



Cod. 57163N
T2

TRAPUNTATO
QUILTED

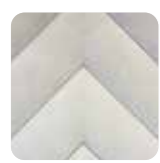

Cod T2



Cod T7

PAILLETES
SEGUINS



Cod PA1



Cod RS1

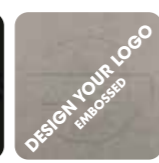

Cod ST

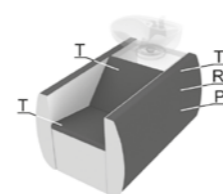

Cod. T: T2 - T7 • R: RS1 • P: PA1

Salone
Sorrento
pag. 20

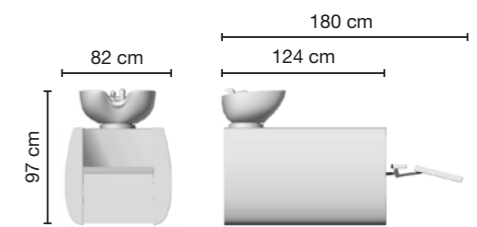



Cod. 57103NA
T7 - RS1



Cod. 57173N



Cod. 57111

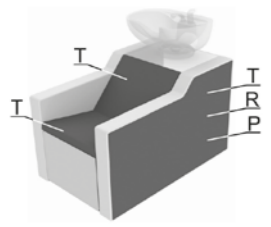

Cod. T: T1 - T7
Cod. R: RF21 - RF23 - RS1
Cod. P: PA1 - PF11

TRAPUNTATO QUILTED			RICAMATO EMBROIDERED			PAILLETTES SEQUINS			DESIGN YOUR LOGO EMBROIDERED		
	Cod T1	Cod T7		Cod RF21	Cod RF23		Cod PA1	Cod PF11		Cod RS1	Cod ST

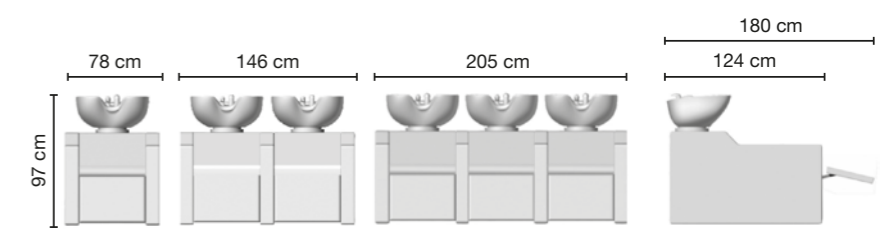



Cod. 57158NA
T1



Cod. 57158A
T1



Cod. 57157A
T4

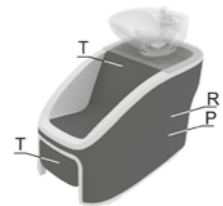
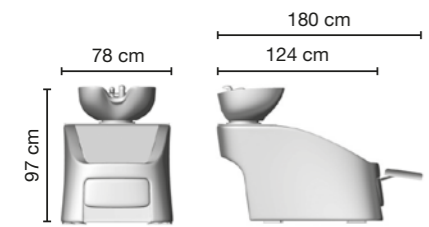

Cod. T: T1
Cod. R: RF21
Cod. P: PF11

TRAPUNTATO
QUILTED

Cod T1 Cod T4 Cod T6

RICAMATO
EMBROIDERED

Cod RA31 Cod RF21 Cod RV11

PAILLETES
SEGUINS

Cod PA1 Cod PF11 Cod PF12 Cod PF13

DESIGN YOUR LOGO
EMBROIDERED

Cod RS1 Cod ST

Cod. T: T1 - T4 - T6
Cod. R: RS1 - RA31 - RF21 - RV11
Cod. P: PA1 - PF11 - PF12 - PF13

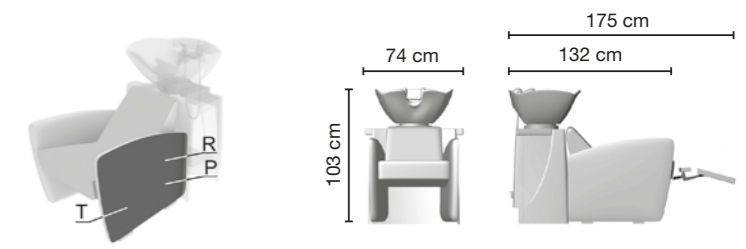



Cod. 57134



Cod. 57174N
T3 - RF23



Cod. 57131N

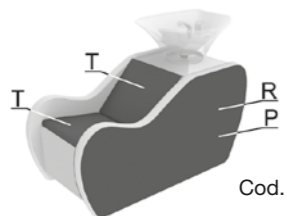

Cod. T: T1 - T3 • R: RS1 - RF21 - RF23 • P: PA1 - PF11

TRAPUNTATO QUILTED			RICAMATO EMBROIDERED			PAILLETTES SEQUINS			DESIGN YOUR LOGO EMBROIDERED		
	Cod T1	Cod T3		Cod RF21	Cod RF23		Cod PA1	Cod PF11		Cod RS1	Cod ST

Salone Brescia pag. 12			



Cod. 57071NV
Vibro massaggio
con alzagambe elettrico



Cod. 57155A



Cod. 57155NSN

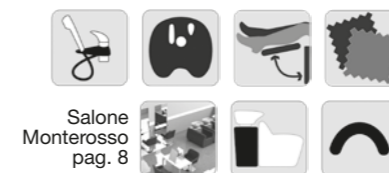
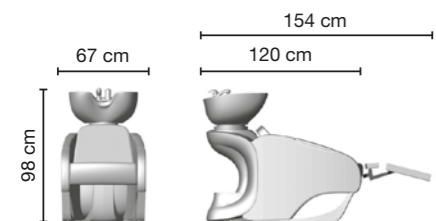

Salone
Monterosso
pag. 8

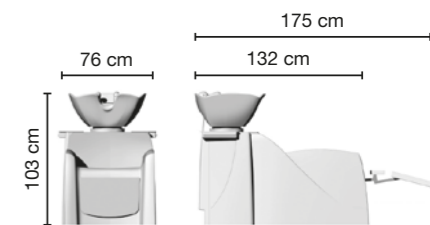



Cod. 57090



Cod. 57160NSN



Cod. 57160

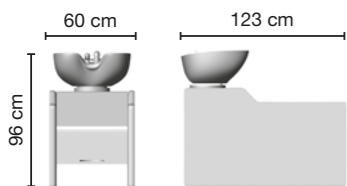

Salone
Tropea
pag. 14





FIBER LARA CONFORT
Cod. 57147NSN



FIBER LARA ICE CONFORT
Cod. 57175



Cod. 57159NSN



Cod. 57159

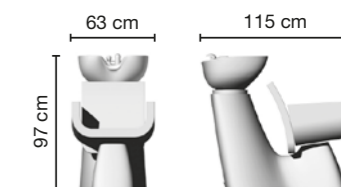
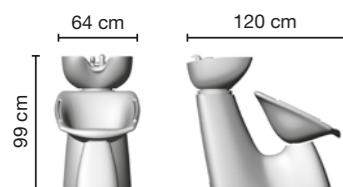



Cod. 57161NSN



Cod. 57161
T1



Cod. 57175



Cod. 57175NSN

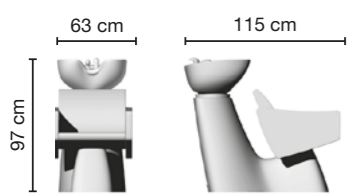

Cod. T: T1 - T3 - T5
Cod. R: RS1 - RF23
Cod. P: PA2 - PF13



**TRAPUNTATO
QUILTED**

Cod T1	Cod T3	Cod T5	Cod T7

**PAILLETES
SEQUINS**

Cod PA1	Cod PA2	Cod PA3	Cod PF11

**RICAMATO
EMBROIDERED**

Cod RF21	Cod RF23

**DESIGN YOUR LOGO
EMBROIDERED**

Cod PF13	Cod RS1	Cod ST

Cod. T: T1 - T5 - T7
Cod. R: RS1 - RF21 - RF23
Cod. P: PA1 - PA2 - PA3 - PF11

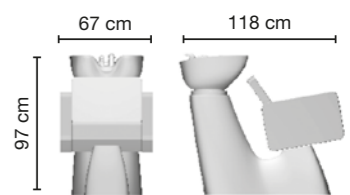



Cod. B57165

GENOVA



Cod. B57164

VENEZIA



Cod. 57168N

GENOVA COLOR



Cod. 57169

VENEZIA COLOR



Salone Donatello pag. 35

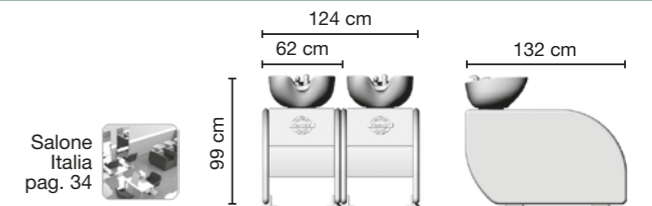

Salone Italia pag. 34





Cod. B57166

MILANO



Cod. B57167

LIVORNO



Cod. 57170

MILANO COLOR



Cod. 57176

LIVORNO COLOR

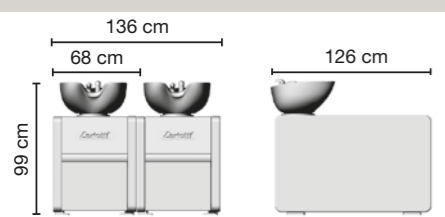

Salone Tintoretto pag. 33
Salone Leonardo pag. 34

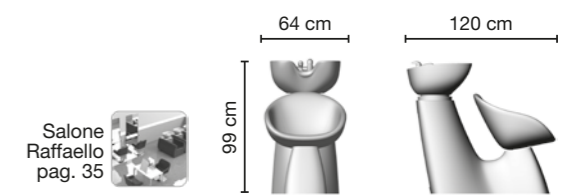

Salone Raffaello pag. 35





NOVI NERO
Cod. 57143NSN



NOVI BIANCO
Cod. 57143



GOLFO
Cod. 7300



SEA ESSE
Cod. 5406N



Esempi di composizione

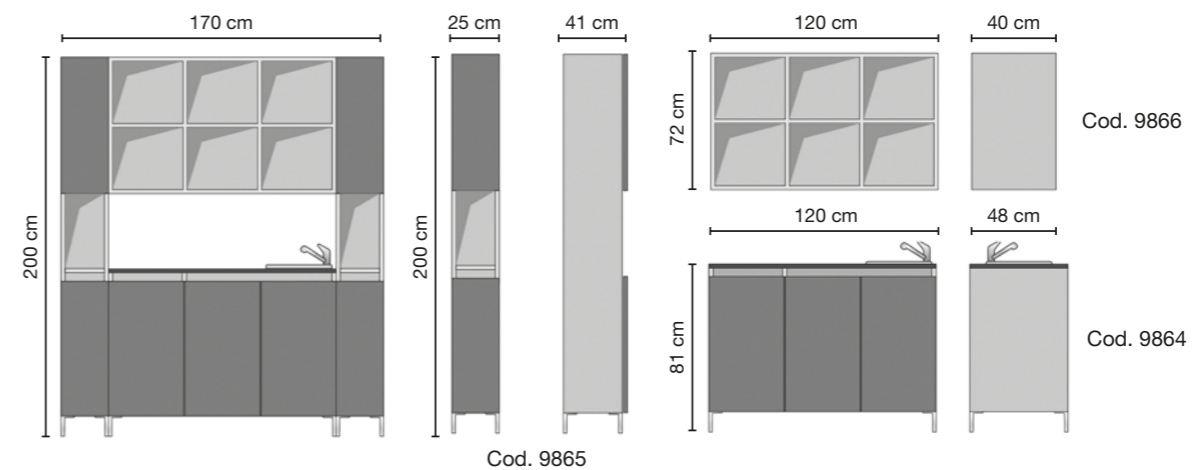

JUPITER 388	pag 146
JUPITER 388 LIMITED EDITION	pag 153
ACADEMY	pag 154
ACADEMY MISURE	pag 158
JUPITER 507	pag 160
OLIVER	pag 162
KENT	pag 164
STYLE • ROYAL	pag 165

.POLTRONE UOMO. .MEN'S CHAIRS.



SKAI S pag 190



LAVORAZIONE STAMPA (SKAI)
 Embossed finish - Finition emboss
 Geprägt Handwerksarbeit - Acabado en relieve



LAVORAZIONE TRAPUNTATA (SKAI)
 Quilted finish - Finition matelassée
 Gestepte Handwerksarbeit - Acabado acolchado



LAVORAZIONE RICAMO (SKAI)
 Embroidered finish - Finition brodée
 Besticktes Handwerksarbeit - Acabado bordado



LAVORAZIONE TAILOR-MADE (SKAI)
 Tailor-Made Finish - Finition Tailor-Made
 Tailor-Made Handwerksarbeit - Acabado Tailor-Made



BASE CON POMPA E FRENO - RIF. 4/M
 Base with hydraulic pump and brake - rif. 4/M
 Base avec pompe hydraulique et frein - rif. 4/M
 Fuß mit hydraulischer arretierbarer Pumpe - rif. 4/M
 Base con bomba hidráulica y freno - rif. 4/M



LAVORAZIONE PAILLETTES (SKAI)
 Decoration with sequins - Décoration avec des paillettes
 Dekoration mit Pailletten - Decoración con lentejuelas



LAVORAZIONE STAMPA PERSONALIZZATA (PREVENTIVO)
 Customized embossed finish (quotation)
 Finition emboss (devis)
 Personalisiert geprägt Handwerksarbeit (Voranschlag)
 Acabado en relieve personalizado (cotización)



LAVORAZIONE RICAMO PERSONALIZZATO (PREVENTIVO)
 Customized embroidered finish (quotation)
 Finition brodée personnalisée (devis)
 Personalisiert besticktes Handwerksarbeit (Voranschlag)
 Acabado bordado personalizado (cotización)



BASE CON POMPA E FRENO - RIF. 4/M NERO
 Base with hydraulic pump and brake - rif. 4/M black
 Base avec pompe hydraulique et frein - rif. 4/M noir
 Fuß mit hydraulischer arretierbarer Pumpe - rif. 4/M schwarz
 Base con bomba hidráulica y freno - rif. 4/M negro



CUSCINO POGGIAGAMBE 388
 Padded cushion for legrest 388
 Coussin rembourré pour repose-jambes 388
 Polsterauflage für Beinstützen 388
 Cojín tapizado para reposapiernas 388



FINITURE S
 Finish S - Finition S
 Verschalung S - Acabado S



SALONE
 Salons - Salons
 Salons - Salons



SPEDIZIONE VELOCE
 Express shipping - Expédition express
 Express Versand - Envío rápido



Cod. 48164SNPP Rif. 4M

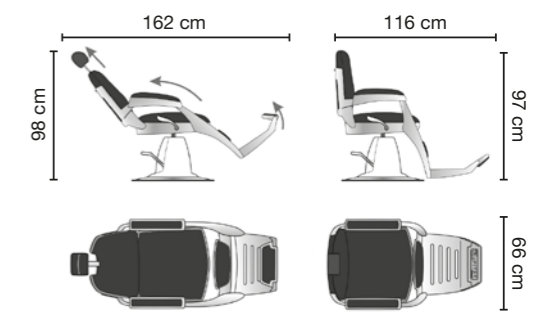

Salone
Michelangelo
pag. 33



Cod. 48164SNPP Rif. 4M
TM



Cod. 48164PP Rif. 4M
TM

TRAPUNTATO
QUILTED

Cod T1

Cod T3

Cod T5

Cod TM

RICAMATO
EMBROIDERED

La bellezza non ha età

Cod RS3 ITA
Cod RS3 ENG
Cod RS3 FRA

PAILLETTES
SEQUINS

Cod PA2

DESIGN YOUR LOGO
EMBROIDERED

Cod RS1

DESIGN YOUR LOGO
EMBOSSED

Cod ST



Cod. T: T1 - T3 - T5 - TM • R: RS1 - RS3 • P: PA2

Salone Tivoli pag. 4

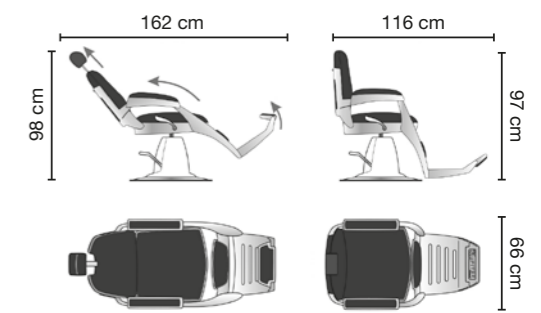



Cod. 48164SNPP Rif. 4M
T5

**TRAPUNTATO
QUILTED**

- Cod T1
- Cod T3
- Cod T5
- Cod TM

**RICAMATO
EMBROIDERED**

La bellezza non ha età

Cod RS3 ITA
Cod RS3 ENG
Cod RS3 FRA

**PAILLETTES
SEQUINS**

Cod PA2

**DESIGN YOUR LOGO
EMBROIDERED**

Cod RS1

**DESIGN YOUR LOGO
EMBOSSED**

Cod ST

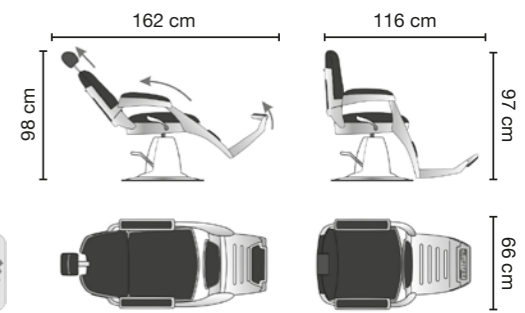
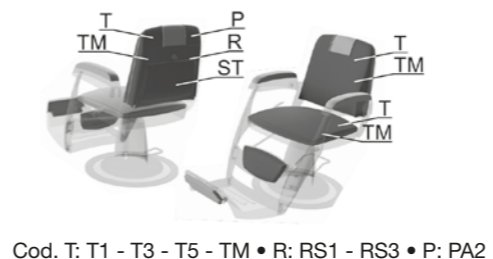



Schienale in alluminio con sistema poggiatesta incorporato.

Aluminum backrest with incorporated headrest.



Marchio Ceriotti e Made in Italy impresso nello schienale. Ulteriore certificazione di origine italiana.

Ceriotti and Made in Italy marks embossed in the backrest. Additional proof of the Italian origin.

Braccioli in alluminio robusti ed eleganti.
Solid and elegant aluminum armrests.



Robusto telaio di alluminio con sistema di tracciatura di origine.
Sturdy aluminum chassis with embossed Made in Italy mark.



Pedana in pressofusione con poggiatesta a ribalta.
Die-cast footrest with tip-over legrest.

Sistema sdraio senza pompa a gas, regolabile e registrabile a piacimento.

Fully adjustable and tunable reclining system without gas pump.

Telaio di sdraio poggiatesta in alluminio. Forma ed eleganza unite alla massima robustezza.

Ceriotti and Made in Italy marks embossed in the backrest. Additional proof of the Italian origin.



Basi con pompa idraulica con freno.
Bases with hydraulic pump and brake

Esperienza, passione e ricerca da oltre 40 anni al servizio del parrucchiere.

Passion, experience, innovation. For over 40 years by your side.



Cod. B48214 Rif. 4M

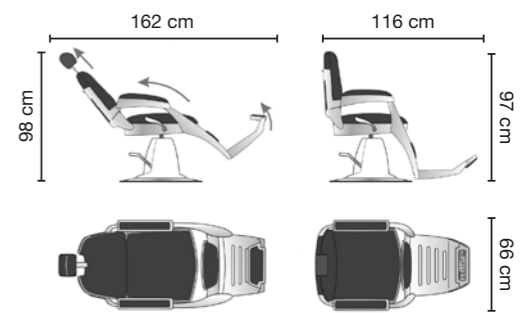





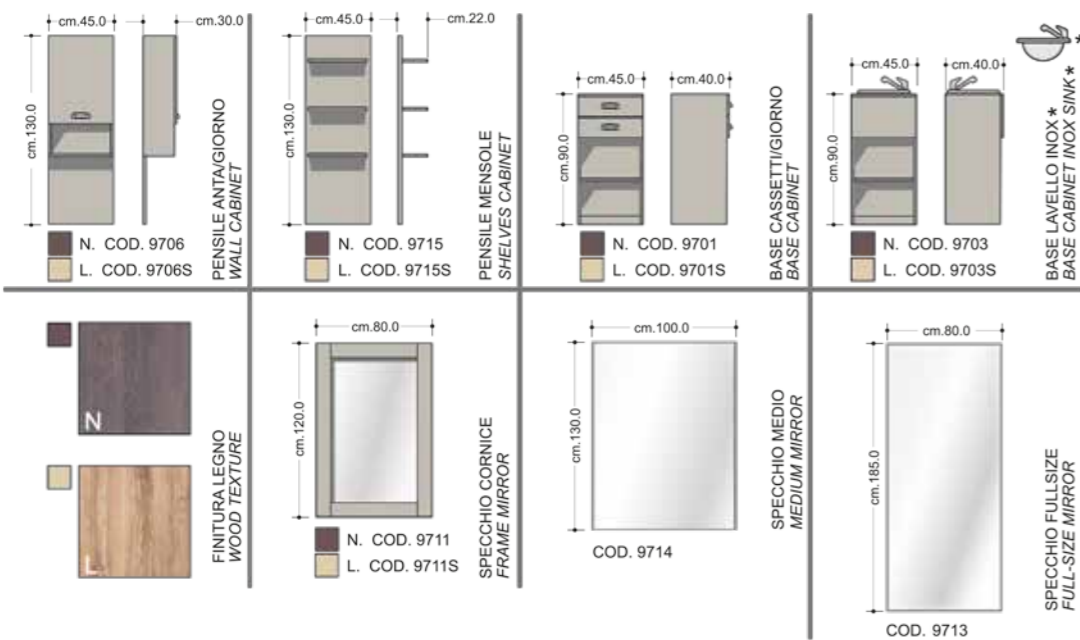

**COMPONENTI SINGOLI
SINGLE ELEMENTS**

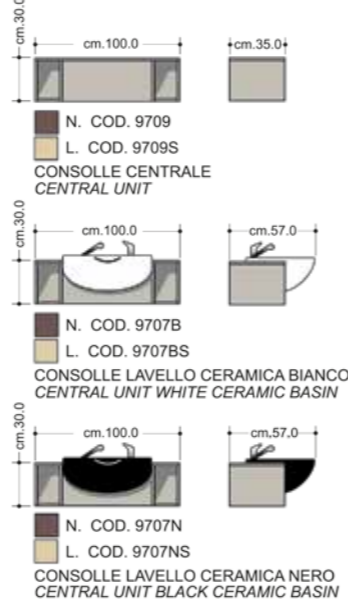

**SOLUZIONI SINGOLE
SINGLE UNITS**

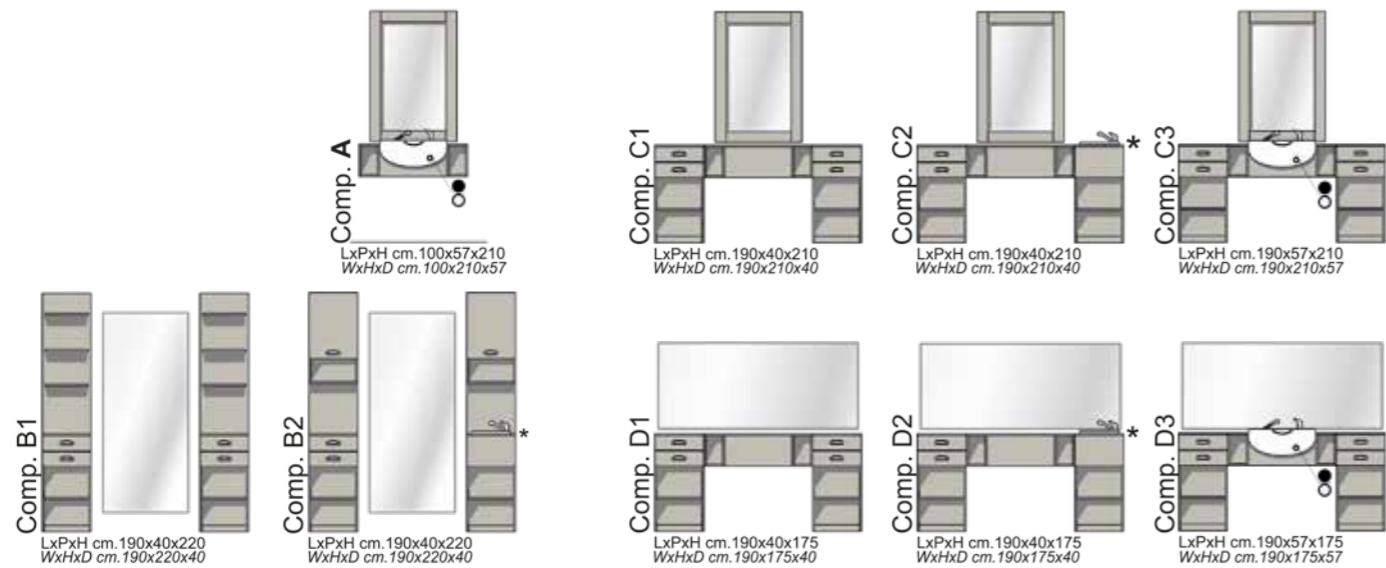

**SOLUZIONI SINGOLE
SINGLE UNITS**

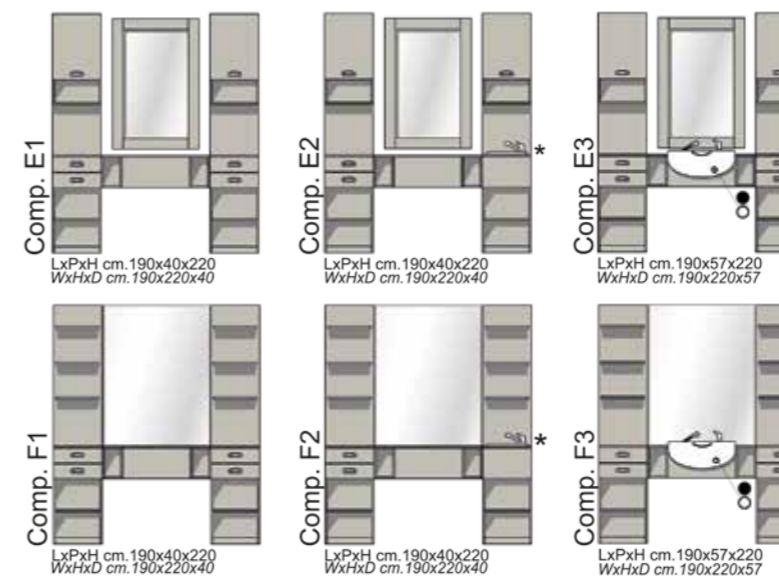

**SOLUZIONI MULTIPLE
MULTIPLE UNITS**





Cod. 48194SN Rif. 4M
T3



Cod. 48194 Rif. 4M



Cod. T: T1 - T3 • R: RS1 • P: PA1 - PA2

TRAPUNTATO QUILTED			PAILLETES SEQUINS			DESIGN YOUR LOGO EMBROIDERED	
	Cod T1	Cod T3		Cod PA1	Cod PA2		Cod RS1

Salone
Monterosso
pag. 6

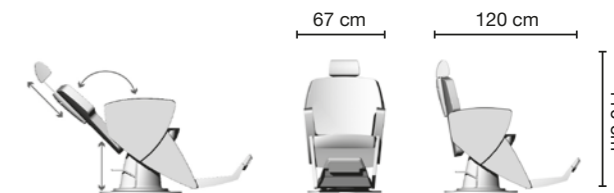



Cod. 48203 Rif. 3M
T6



Cod. 48203 Rif. 3M



Cod. 48204SN Rif. 4M



Cod. T: T1 - T6 • R: RS1 • P: PA1 - PA2 - PA3

TRAPUNTATO QUILTED			PAILLETTES SEQUINS				DESIGN YOUR LOGO EMBROIDERED	
	Cod T1	Cod T6		Cod PA1	Cod PA2	Cod PA3		

Salone
Napoli
pag. 32

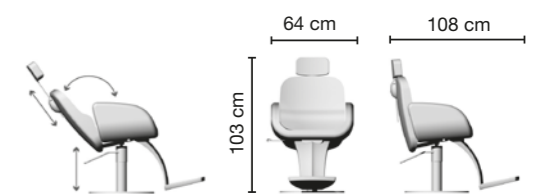

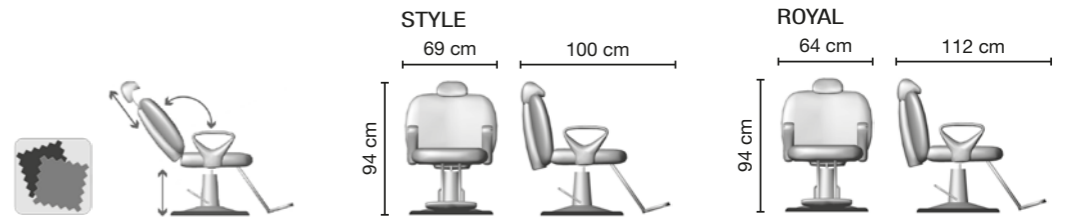

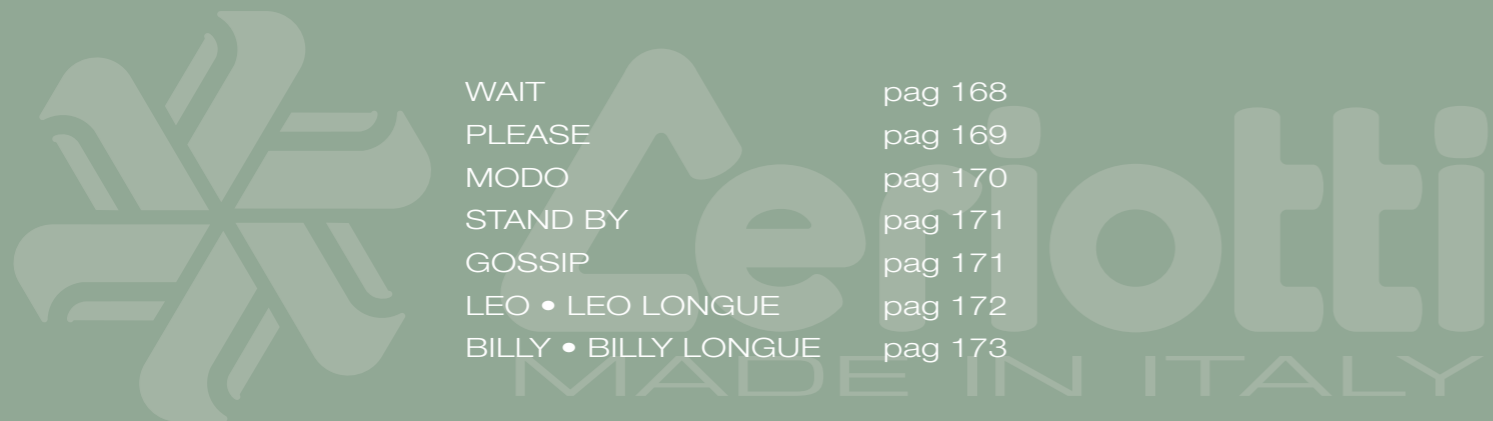

WAIT	pag 168
PLEASE	pag 169
MODO	pag 170
STAND BY	pag 171
GOSSIP	pag 171
LEO • LEO LONGUE	pag 172
BILLY • BILLY LONGUE	pag 173

**.DIVANETTI.
.SOFAS.**



SKAI S pag 190



LAVORAZIONE RICAMO (SKAI)
Embroidered finish - Finition brodée
Besticktes Handwerksarbeit - Acabado bordado



LAVORAZIONE STAMPA (SKAI)
Embossed finish - Finition emboss
Geprägt Handwerksarbeit - Acabado en relieve



LAVORAZIONE PAILLETES (SKAI)
Decoration with sequins - Décoration avec des paillettes
Dekoration mit Pailletten - Decoración con lentejuelas



LAVORAZIONE TRAPUNTATA (SKAI)
Quilted finish - Finition matelassée
Gesteppte Handwerksarbeit - Acabado acolchado



LAVORAZIONE STAMPA PERSONALIZZATA (PREVENTIVO)
Customized embossed finish (quotation)
Finition emboss (devis)
Personalisiert geprägt Handwerksarbeit (Voranschlag)
Acabado en relieve personalizado (cotización)



LAVORAZIONE RICAMO PERSONALIZZATO (PREVENTIVO)
Customized embroidered finish (quotation)
Finition brodée personnalisée (devis)
Personalisiert besticktes Handwerksarbeit (Voranschlag)
Acabado bordado personalizado (cotización)



SALONE
Salons - Salons
Salons - Salons



Cod. 61181



Cod. 61191
T

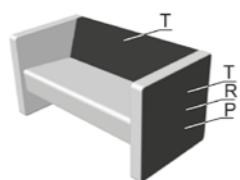

Cod. T: T1 - T7 • R: RS1 - RS3 • P: PA1 - PF11

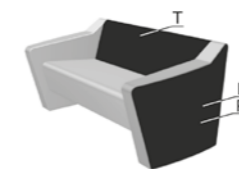

Cod. T: T1 - T7 • R: RS1 - RS3 - RF21 • P: PA1 - PF11

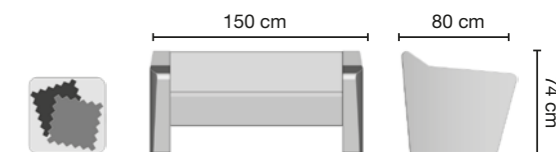
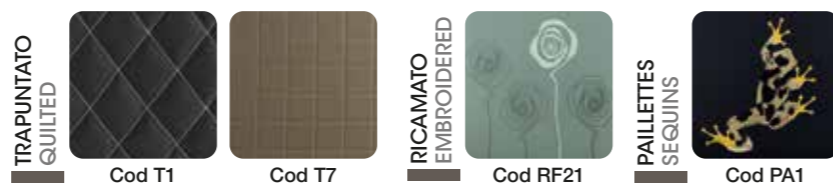
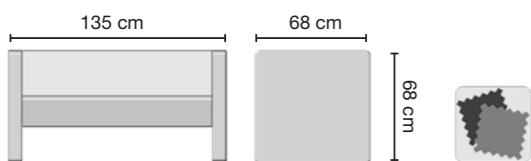

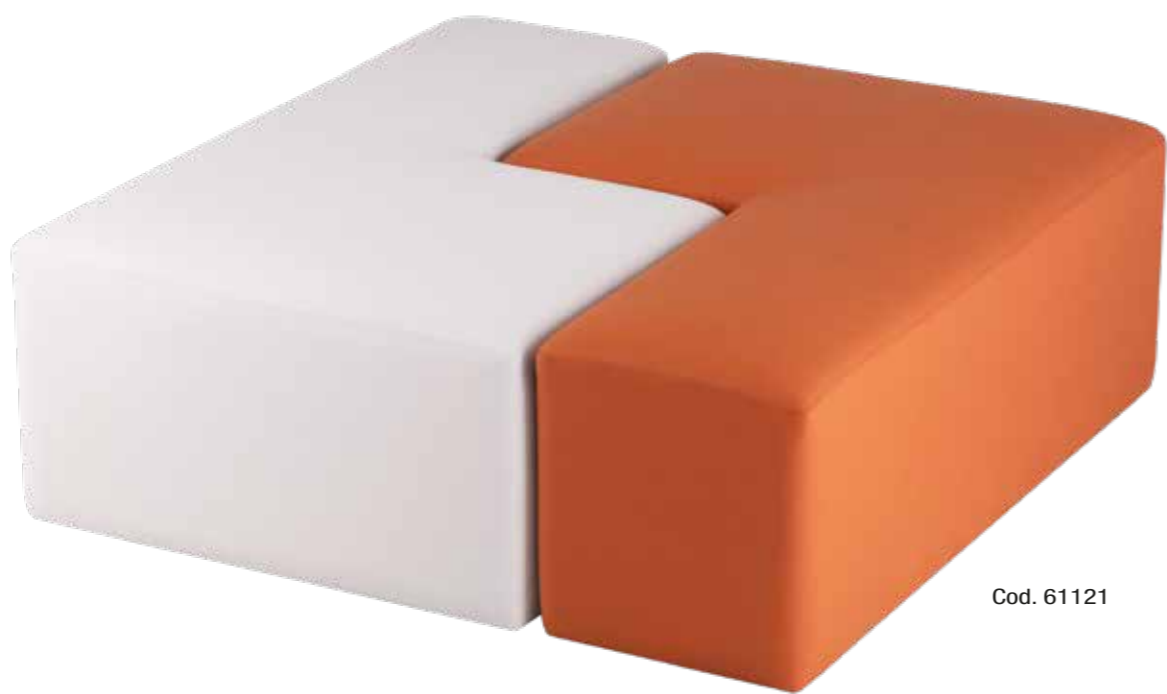

Cod. 61121



Cod. 61132

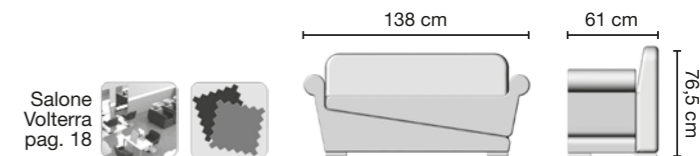

STAND BY

GOSSIP



Cod. 60162



Cod. 61062

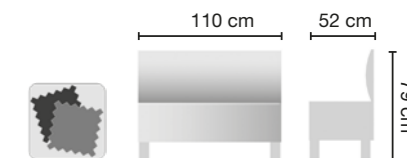



LEO
Cod. 4921
T2 - T5

LEO LONGUE
Cod 61171
T7



BILLY
Cod. 4920
RA31

BILLY LONGUE
Cod. 61161
T1

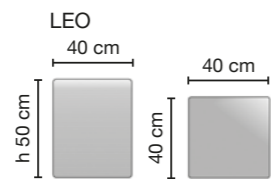
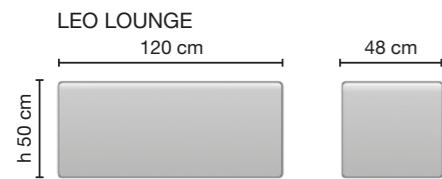

Salone Tivoli pag. 4
Salone Ivrea pag. 10
Salone Brescia pag. 12
Salone Tropea pag. 14
Salone Volterra pag. 18
Salone Sorrento pag. 20
Salone Sanremo pag. 26

Salone Monterosso pag. 6
Salone Brescia pag. 12
Salone Tropea pag. 14
Salone Amalfi pag. 16
Salone Sorrento pag. 20
Salone Modena pag. 22
Salone Arona pag. 24
Salone Burano pag. 30

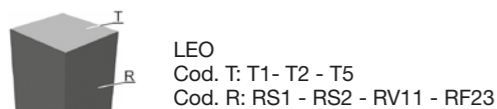
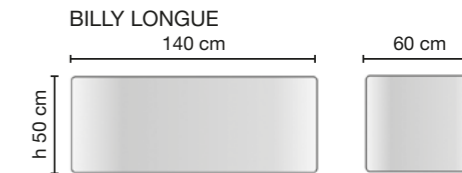
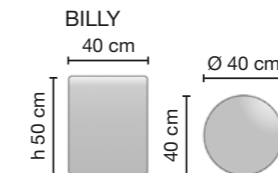

LEO
Cod. T: T1 - T2 - T5
Cod. R: RS1 - RS2 - RV11 - RF23

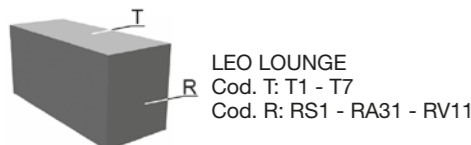

LEO LONGUE
Cod. T: T1 - T7
Cod. R: RS1 - RA31 - RV11

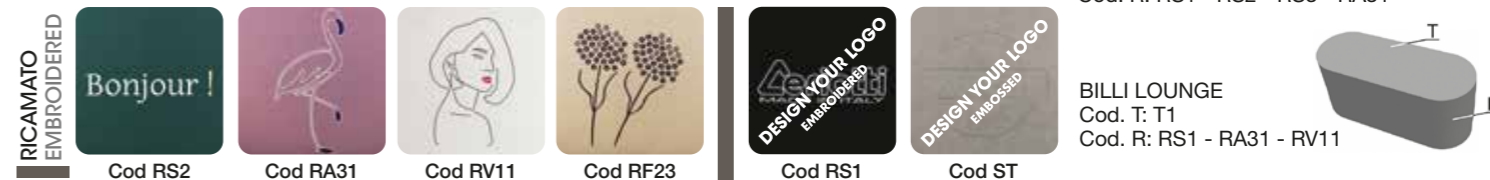

BILLY
Cod. T: T1 - T6 - T7
Cod. R: RS1 - RS2 - RS3 - RA31

BILLY LONGUE
Cod. T: T1
Cod. R: RS1 - RA31 - RV11

B-SIDE	pag 176
HALL	pag 177
MEETING	pag 178
AMYRA	pag 179
VOLUME	pag 180
STONE	pag 181
SHANGAI	pag 182
COUNTER	pag 183
CURVY	pag 184
FINITURE LEGNO	pag 185

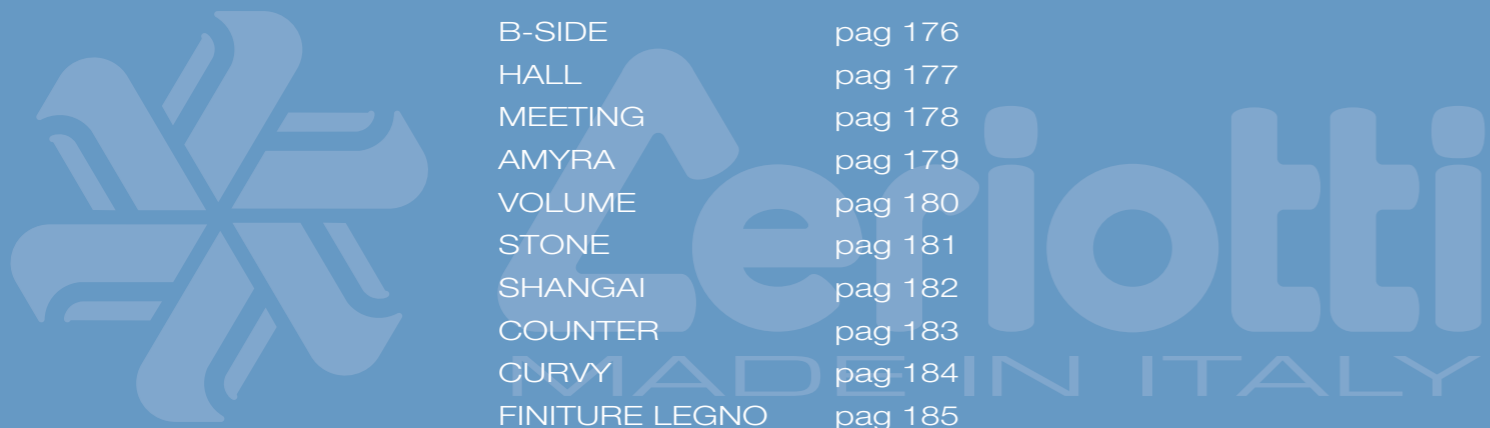

**.CASSE.
RECEPTIONS.**



FINITURE S pag 185
 Finish S - Finition S
 Verschalung S - Acabado S



SKAI S pag 190



LAVORAZIONE STAMPA (SKAI)
 Embossed finish - Finition emboss
 Geprägt Handwerksarbeit - Acabado en relieve



LAVORAZIONE TRAPUNTATA (SKAI)
 Quilted finish - Finition matelassée
 Gestepte Handwerksarbeit - Acabado acolchado



ILLUMINAZIONE
 Lighting - Éclairage
 Beleuchtung - Iluminación



LAVORAZIONE RICAMO (SKAI)
 Embroidered finish - Finition brodée
 Besticktes Handwerksarbeit - Acabado bordado



LAVORAZIONE PAILLETES (SKAI)
 Decoration with sequins - Décoration avec des paillettes
 Dekoration mit Pailletten - Decoración con lentejuelas



LAVORAZIONE STAMPA PERSONALIZZATA (PREVENTIVO)
 Customized embossed finish (quotation)
 Finition emboss (devis)
 Personalisiert geprägt Handwerksarbeit (Voranschlag)
 Acabado en relieve personalizado (cotización)



COLORE NERO
 Black colour - Couleur noire
 Schwarze Farbe - Color negro



LAVORAZIONE RICAMO PERSONALIZZATO (PREVENTIVO)
 Customized embroidered finish (quotation)
 Finition brodée personnalisée (devis)
 Personalisiert besticktes Handwerksarbeit (Voranschlag)
 Acabado bordado personalizado (cotización)



SALONE
 Salons - Salons
 Salons - Salons



Cod. 9938
T7



Cod. 9938

Cod. 9938D

Cod. 9937

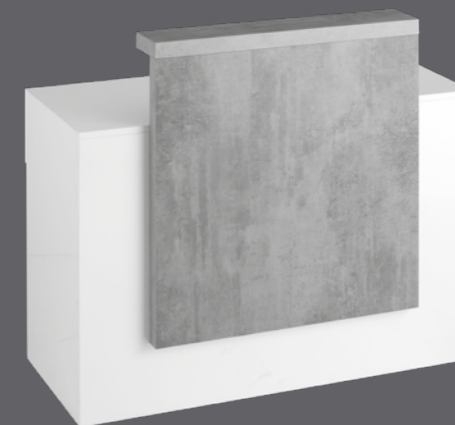

Cod. 9937
RV11

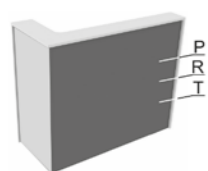

Cod. T: T1 - T2 - T7
Cod. R: RS1 - RS3 - RF21
Cod. P: PA1 - PA3 - PF11

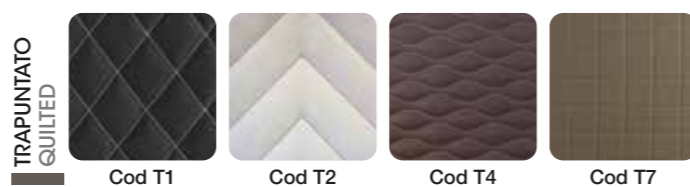

Cod. T: T1 - T4 - T7
Cod. R: RS1 - RS3 - RF21 - RV11
Cod. P: PA1 - PA3 - PF12 - PF13

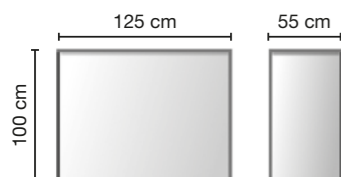
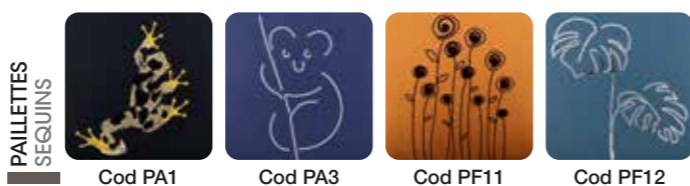
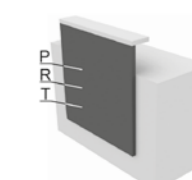

Salone Tropea pag. 14
Salone Sanremo pag. 26
Salone Matera pag. 28

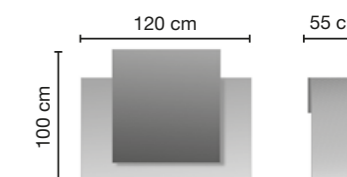
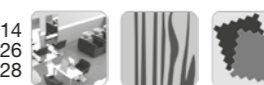



Cod. 9909

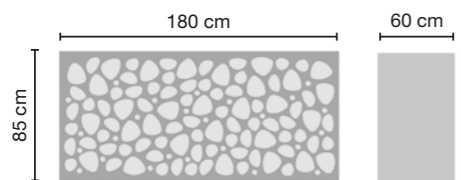

Salone
Brescia
pag. 12



Cod. 9911SN

Salone Arona pag. 24
Salone Burano pag. 30





Cod. 9926S



Cod. 9926

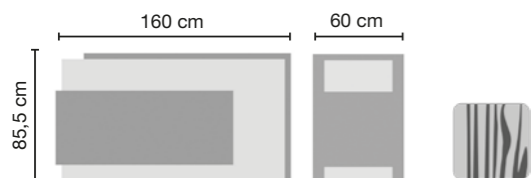

Cod. 9927

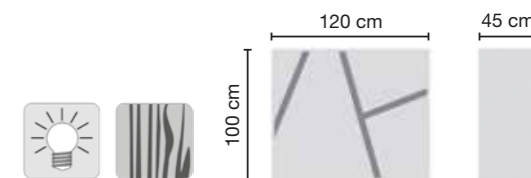



Cod. 9939S



Cod. 9929S



SHANGAI SOFT
Cod. 9940
RA31



SHANGAI
Cod. 9939



Cod. 9929
RF21

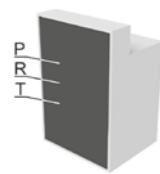
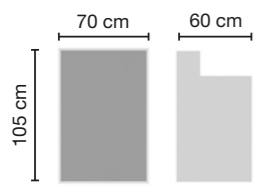

SHANGAI SOFT
Cod. T: T1 - T2 - T7
Cod. R: RS1 - RS3 - RA31
Cod. P: PA1 - PA3 - PF11

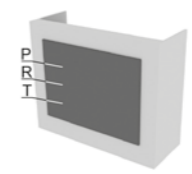
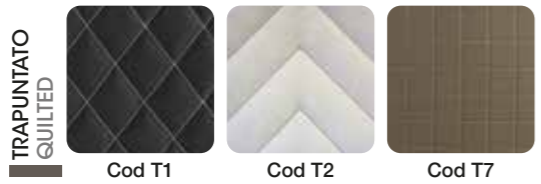

Cod. T: T1 - T2 - T7
Cod. R: RS1 - RS3 - RF21
Cod. P: PA1 - PF11 - PF12

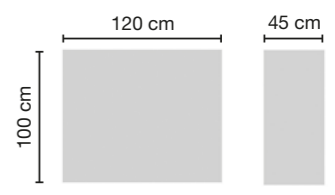
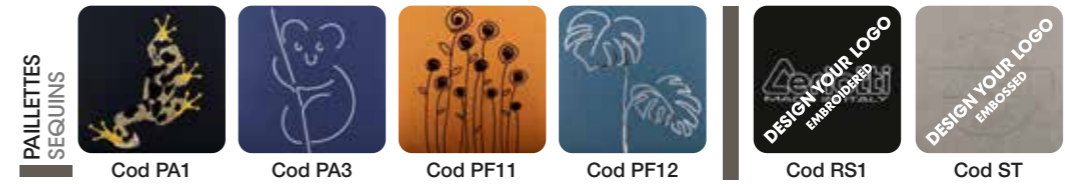

FINITURE LEGNO

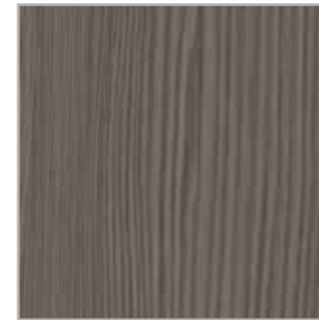

NOBILITATO OLMO FUMÈ
4521



NOBILITATO OLMO DEKAPÈ
4523



NOBILITATO OLMO ROSÈ
4522



NOBILITATO SELECT 2
10587



NOBILITATO SELECT 1
10698



NOBILITATO WENGÈ
4519



NOBILITATO BETON
4520



NOBILITATO BIANCO
001



NOBILITATO NERO
002



LAMINATO LEGNO
003



FRASSINO
004



Cod. 9935S

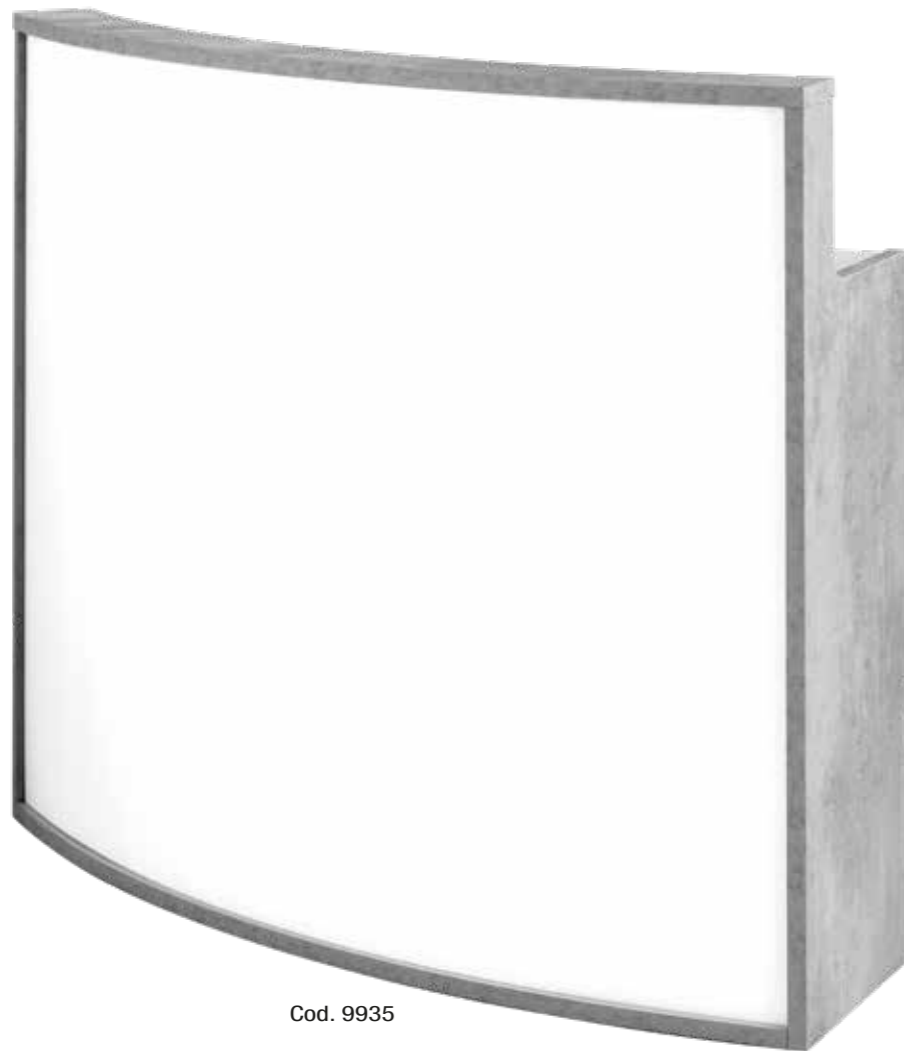

Cod. 9935

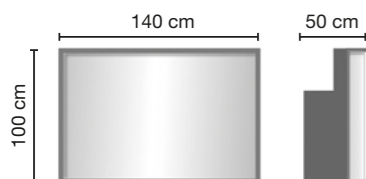

Salone Sorrento pag. 20
Salone Modena pag. 22



Alta Sartoria italiana

I primi in Italia nelle lavorazioni di alta sartoria nel settore dell'arredo per parrucchieri.

“Il solo uomo davvero dotato di sensibilità che conosco è il mio sarto: mi prende le misure tutte le volte che mi vede. Gli altri mantengono le vecchie misure e si aspettano che io mi ci adatti.”

“The only man I know who behaves sensibly is my tailor; he takes my measurements anew each time he sees me. The rest go on with their old measurements and expect me to fit them.”

George Bernard Shaw

Da quasi mezzo secolo, noi di Cerioti creiamo soluzioni di arredamento uniche, cucite con cura sartoriale intorno alle esigenze degli acconciatori. Per celebrare la cultura dello stile italiano, abbiamo disegnato la collezione "Alta Sartoria Italiana", creata per esaltare la cura e la passione che mettiamo ogni giorno nella realizzazione dei nostri prodotti e con la quale vogliamo offrirti - ancora una volta - la più ampia scelta di soluzioni per personalizzare il tuo salone. Tutto questo, con la garanzia della qualità 100% Made in Italy che da sempre contraddistingue Cerioti.

For almost half a century, we at Cerioti have been creating unique furnishing solutions, tailored with sartorial care around the needs of the hairstylists. To celebrate the culture of Italian style, we designed the "Alta Sartoria Italiana" collection, created to enhance the care and passion we put every day into creating our products and with which we want to offer you - once again - the widest choice of solutions to personalize your salon. All of this, with the guarantee of 100% Made in Italy quality that has always distinguished Cerioti.

Depuis presque un demi-siècle, dans Cerioti nous créons des solutions d'ameublement uniques, réalisées avec le soin d'un tailleur autour des besoins des coiffeurs. Pour célébrer la culture du style italien, nous avons conçu la collection "Alta Sartoria Italiana", créée pour exalter le soin et la passion que nous consacrons chaque jour à la création de nos produits, et avec laquelle nous souhaitons offrir - encore une fois - le plus vaste choix de solutions pour personnaliser votre salon. Tout cela, avec la garantie d'une qualité 100% Made in Italy qui a toujours distingué Cerioti.

Seit fast einem halben Jahrhundert, entwickelt Cerioti einzigartige Einrichtungslösungen, die auf die Bedürfnisse von Friseuren zugeschnitten sind. Um die Kultur des italienischen Stils zu feiern, wir haben die Kollektion "Alta Sartoria Italiana" entworfen, die geschaffen wurde, um die Sorgfalt und Leidenschaft, die wir jeden Tag in die Gestaltung unserer Produkte stecken, zu verbessern, und mit denen - noch einmal - wir bieten Ihnen die größte Wahl an Lösungen zur Personalisierung Ihres Salons. Dies alles mit der Garantie von 100% Made in Italy-Qualität, die Cerioti seit jeher auszeichnet.

Durante casi medio siglo, en Cerioti creamos soluciones de mobiliario únicas, diseñadas con cuidado sartorial alrededor de las necesidades de los estilistas. Para celebrar la cultura del estilo italiano, hemos diseñado la colección "Alta Sartoria Italiana", creada para exaltar el cuidado y la pasión que ponemos cada día en la creación de nuestros productos, y con la que queremos ofrecerte - una vez más - la más amplia variedad de soluciones para personalizar tu salón. Todo esto, con la garantía de calidad 100% Made in Italy que siempre ha distinguido a Cerioti.



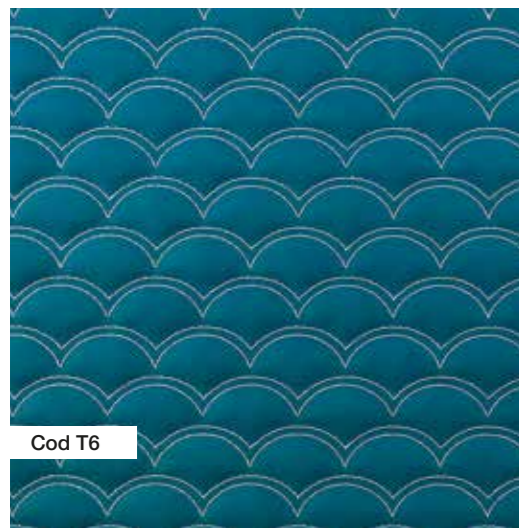

Cod T6

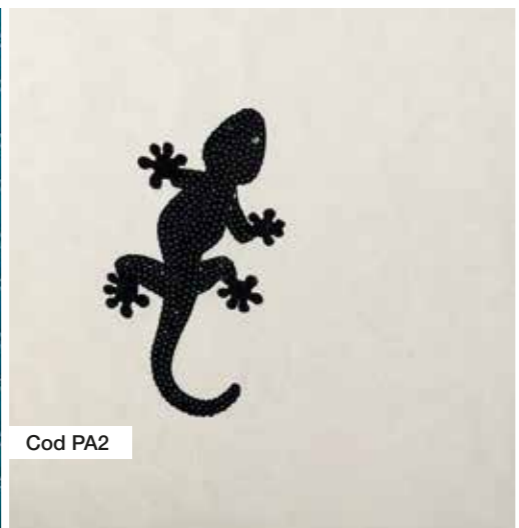

Cod PA2



Cod T5



Cod RS2



Cod T2



Cod PS21

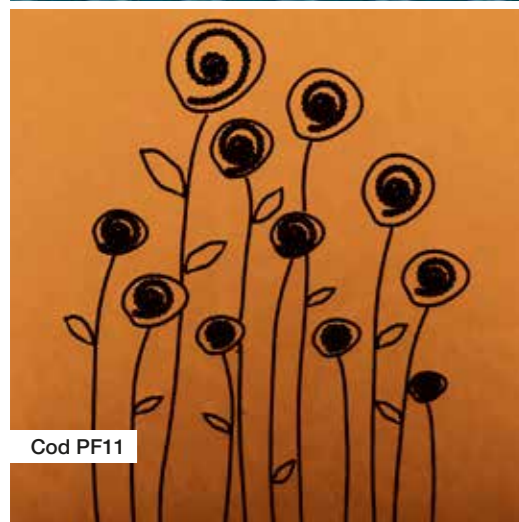

Cod PF11



Cod RS3 ITA

Cod RS3 ENG

Cod RS3 FRA



Cod RF21

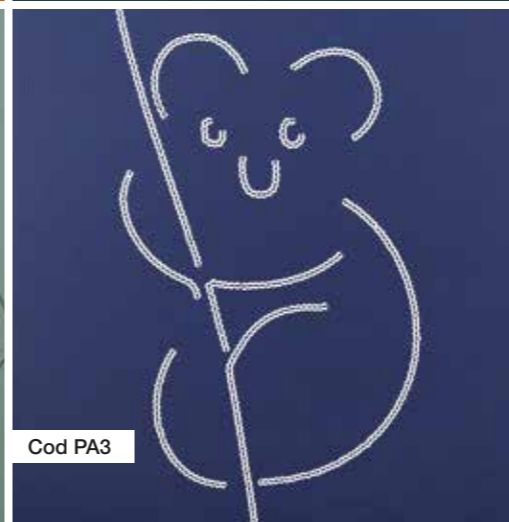

Cod PA3



Cod PA1

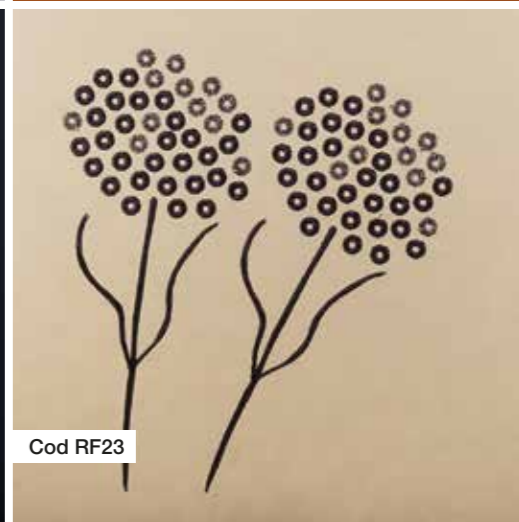

Cod RF23



Cod T7



Cod T3



Cod RA31

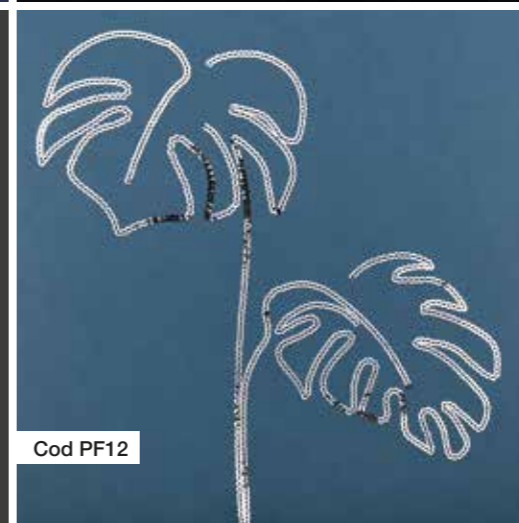
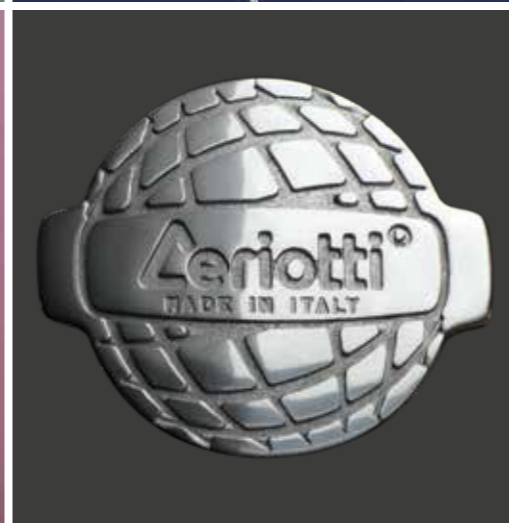

Cod PF12

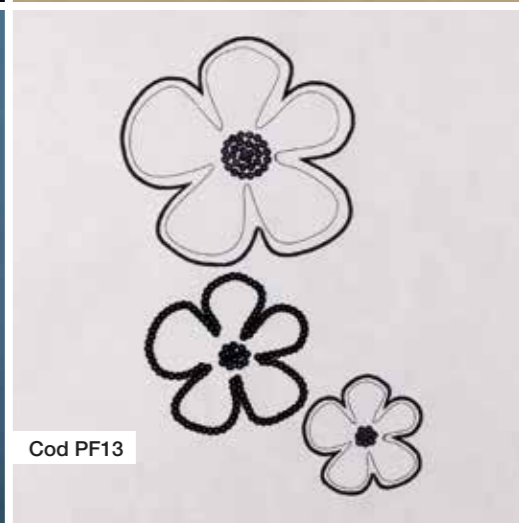

Cod PF13



Cod RV11



Cod RF22



Cod RS1



Cod ST

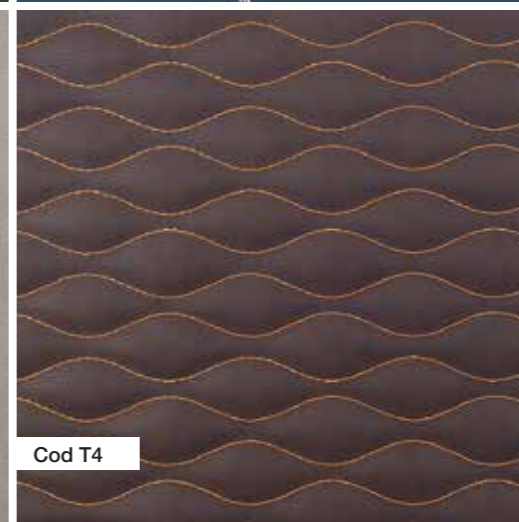

Cod T4

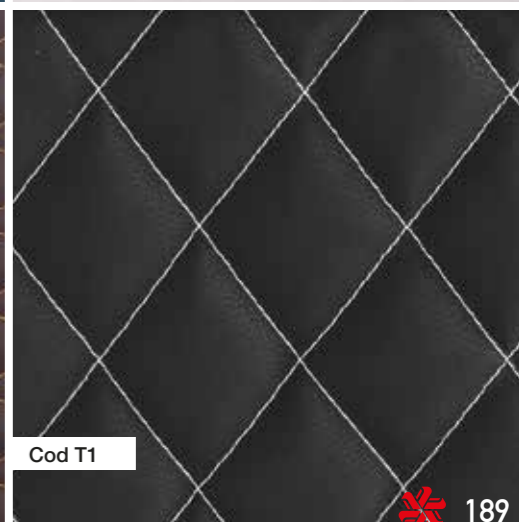

Cod T1



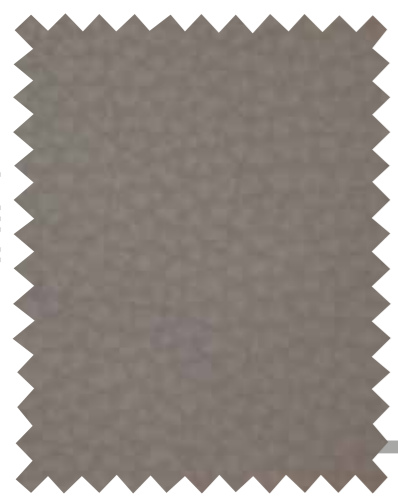

789
L



313S



947S

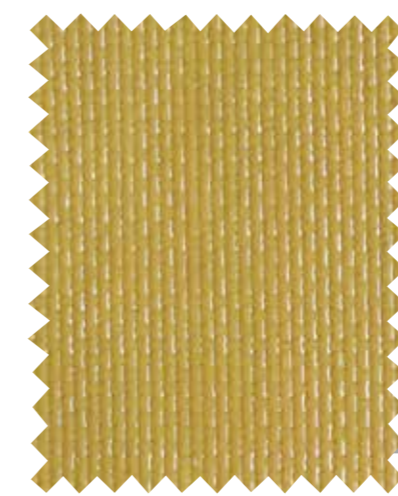

113S



111S



112S
L



231S



233S



205
L



676S



990S



001
L



070S



693S



745
L



792
L



948S



190S



069S



101
L



209S



096S



081S



195
L



646S



767S



571S



510
L



511
L



941S



198



210
L



572S



793
L



705S



126S



939S



787
L



643S



259
L



203S



797
L



180S



788
L



790
L



714
L



025S



514
L





691S



734
L



736
L



182S



183S



184S



796
L



754S



702S



071S



357



577S



680S



512
L



795
L



074S



679S



791
L



731
L



798
L



513
L



205S



749S



750S



Condizioni Generali di vendita: vedi Listino Prezzi in vigore

Per esigenze tecniche di funzionalità e di estetica, la ditta costruttrice può, in qualsiasi momento e senza obbligo di avvisare la committente, apportare modifiche agli articoli esposti nel catalogo generale. Gli esempi di colore contenuti nel presente catalogo, sono da ritenersi puramente indicativi per quanto ottenuti con le tecniche più sofisticate di stampa.

Le misure sono da ritenersi puramente indicative.

General Conditions of Sale: see current Price List

For reasons of technical, functional and aesthetic nature, the manufacturer may, at any moment, and without any obligation of giving prior notice to the customer, make any modifications he may deem necessary to the articles presented in the general catalogue. - Although the most advanced techniques have been used in printing this catalog, the examples of colors contained within are to be considered purely indicative.

Measures must be considered purely indicative.

Conditions générales de vente: voir Tarifs actuelles

Pour toute nécessité technique liée à la fonctionnalité et à l'esthétique, le fabricant peut, à tout moment et sans avertir le client, apporter des modifications aux articles présentés dans le catalogue général. Les exemples de couleurs présentés dans ce catalogue doivent être considérés comme étant purement indicatifs, dans la mesure où ils sont réalisés avec les techniques d'impression les plus sophistiquées.

Les mesure doivent être considérées comme purement indicatives.

Allgemeine Verkaufsbedingungen: siehe aktuelle Preisliste

Die Herstellerfirma kann aus technischen Gründen der Zweckmäßigkeit und Ästhetik jederzeit und ohne vorherige Benachrichtigungspflicht die im Gesamtkatalog vorgestellten Artikel Änderungen unterwerfen. Die im vorliegenden Katalog abgebildeten Farbmuster müssen trotz Einsatz der besten verfügbaren Drucktechniken als unverbindliche Muster gelten.

Die Mussnahmen müssen als rein bezeichnend betrachtet werden.

Condiciones generales de venta: ver Lista precios actual

Por exigencias técnicas de funcionalidad y estética, la fabrica constructora puede, en cualquier momento y sin obligación de avisar el comisionado, aportar cambios en los artículos expuestos en el catálogo general. Los colores que publicamos en el presente catálogo se han de considerar exclusivamente como ejemplos, puesto que los mismos se obtienen por medio de las técnicas de impresion más sofisticadas.

Las medidas deben considerarse meramente indicativas.



Ceriotti srl - 20017 RHO (MI) Italy - via Moscova, 21
Tel. +39.02.93561413 - Fax +39.02.93561646 - Mail info@ceriotti.it
Web www.ceriotti.it